

WOLFFKRAN

Edition 09|2022



Produktübersicht | Product program / La gamme de grues

Impressum

Imprint

Impression

Herausgeber / Publisher / Editeur: WOLFFKRAN International AG, Schweiz

Das Taschenbuch zeigt einen allgemeinen Überblick über das Kranprogramm der WOLFFKRAN International AG. Verbindliche technische Informationen und Vorschriften sind jedoch dem jeweiligen Betriebsbuch des Krantyps zu entnehmen. Technische und inhaltliche Änderungen sind vorbehalten.

This book provides a general overview of the range of cranes available from WOLFFKRAN International AG. Binding technical information and regulations have been specified in the respective operating manuals of the specific crane types. All rights reserved regarding technical and content changes.

Le livre de poche présente une vue d'ensemble générale de la gamme des grues de WOLFFKRAN International AG. Mais des informations techniques fermes et prescriptions sont toutefois contenues dans le manuel de service respectif du type de chaque grue. Sous réserve de modifications techniques et de fond.

WOLFFKRAN GmbH: Zertifiziert nach DIN EN ISO 9001 / Certified according DIN EN ISO 9001 / Certifié selon DIN EN ISO 9001





WOLFFKRAN Inhaltsverzeichnis / Table of contents / Table des matières

WOLFF	Typenübersicht, Mietkrananfrage product range, enquiry for rental / Gamme des grues, demande d'offre de location grue	5 – 9
WOLFF	Turmkrane mit Laufkatzausleger Tower cranes with trolley jib / Grue à tour à flèche horizontale	11 – 146
WOLFF	Turmkrane mit Wippausleger Tower cranes with luffing jib / Grue à tour à flèche relevable	147 – 206
WOLFF	Elektrische Anschlusswerte Electric connection values / Puissance électrique	209 – 214
WOLFF	System-Komponenten System-components / Système de composants	217 – 247















WOLFFKRAN Gruppe

WOLFFKRAN Group / **WOLFFKRAN** Groupe









Alle aktuellen **WOLFFKRANE** können in Absprache nach individuellen Bedürfnissen angepasst werden.
All cranes in current production can be customised – this must be discussed and agreed.
C'est possible la gamme des grues **WOLFF** d'adapter – il faut les adaptations de discuter.



WOLFF Turmkrane mit Laufkatzausleger
Tower cranes with trolley jib
Grue à tour à flèche horizontale

Typ Type Type	BGL Grp. BGL grp. Grp. BGL C.0.10.	Max. Traglast Max. load Charge maxi (kg) bei/at/à (m)	Ausladung (m) und Tragfähigkeit (kg) Radius (m) and lifting capacity (kg) Portée (m) et capacité de charge (kg)																	Seite Page Page
			25	30	35	40	45	50	55	60	65	70	75	80	85	90	100	m		
4518 City		0080	6000	17,3	4000	3200	2700	2200	1800	1400										12
5014 City		0090	6000	17,8	4100	3300	2700	2200	1800	1400										18
5020.6 Clear		0112	6200	20,0	5500	4400	3600	3000	2500	2000	1500									24
5020.8 Clear		0112	8500	17,0	5500	4400	3600	3000	2500	2000	1500									30
6020.6 Clear		0140	6200	27,7	6200	5600	4700	4100	3500	3000	2400	2000								36
6020.8 Clear		0140	8500	20,2	8500	5400	4500	3900	3300	2800	2200	1800								42
6023.6 Clear		0180	6200	35,5	6200	6200	6200	5200	4400	3700	3100	2300								48
6023.8 Clear		0180	8500	26,6	8500	7400	6200	5200	4400	3700	3100	2300								54
6031.8 Clear		0224	8500	30,5		8500	7300	6200	5200	4400	3700	3100	2300							62
6031.12 Clear		0224	12000	21,5		8200	7000	5900	4900	4100	3400	2800	2000							68
7032.8 Clear		0250	8500	37,9	8500	8500	8500	8000	6900	6000	5100	4400	3800	3200						76
7032.12 Clear		0250	12000	27,3	12000	10800	9000	7700	6600	5700	4800	4100	3500	2900						82
7534.8 Clear		0315	8500	43,6		8500	8500	8500	8200	7100	6200	5400	4800	4100	3400					90
7534.16 Clear		0315	16500	24,1		13000	10700	8900	7800	6700	5800	5000	4400	3700	3000					96

WOLFF Turmkrane mit Laufkatzausleger
 Tower cranes with trolley jib
 Grue à tour à flèche horizontale

Typ Type Type	BGL Grp. BGL grp. Grp. BGL C.0.10.	Max. Traglast Max. load Charge maxi (kg) bei / at / à (m)	Ausladung (m) und Tragfähigkeit (kg) Radius (m) and lifting capacity (kg) Portée (m) et capacité de charge (kg)																	Seite Page Page	
			25	30	35	40	45	50	55	60	65	70	75	80	85	90	100	m			
8033.8 Cross		0450	8500	55,0		8500	8500	8500	8500	8500	8500	7500	6500	5500	4500	3300					104
8033.16 Cross	 	0450	16500	29,5		16200	13600	11700	10200	9000	8100	7100	6100	5100	4100	2900					110
8033.20 Cross		0450	20000	24,5		16000	13400	11500	10000	8800	7800	6800	5800	4800	3800	2600					116
6071 Cross		0560	20000	31,8		20000	18000	15000	13000	11300	9600	7100									122
8060.25 Cross		0630	25000	30,0		25000		17500	15000	13000	11300	10000	8800	7700	6800	6000					128
8060.50 Cross	 	0630	50000	15,2		24500		16100	13500	11400	9600	8300	7100	5900	5000	4200					134
8076 Compact		0800	40000	25,9		34000	28500	24000	20000	17300	15100	13300	11600	10100	8600	7600					140

WOLFF Turmkrane mit Wippausleger / Tower cranes with luffing jib / Grue à tour à flèche relevable

Typ Type Type	BGL Grp. BGL grp. Grp. BGL C.0.11.	Max. Traglast Max. load Charge maxi (kg) bei/at/à (m)	Ausladung (m) und Tragfähigkeit (kg) Radius (m) and lifting capacity (kg) Portée (m) et capacité de charge (kg)																	Seite Page Page		
			25	30	35	40	45	50	55	60	65	70	75	80	85	90	100	m				
133.6 B		0125	3100	40,0	3100	3100	3100	3100	2600												148	
		0125	6200	28,7	6200	5900	4700	3500	2500													
133.8 B		0125	4000	35,2	4000	4000	4000	3300	2300													154
		0125	8000	22,8	7200	5500	4300	3100	2100													
166 B		0160	6000	35,0	6000	6000	6000	4600	3600	2800	1800											160
		0160	12000	21,0	10000	7500	5800	4400	3400	2600	1600											
235 B		0224	8000	35,0	8000	8000	8000	6400	5000	3700	2500	1600										166
		0224	16000	18,5	11800	9800	7800	6000	4600	3300	2100	1200										
275 B		0250	12000	30,0		12000	10000	7900	6200	4800	3600	2400										172
		0250	24000	16,1		12200	9700	7600	5900	4500	3300	2100										
355 B		0355	14000	30,0		14000	13800	11600	9000	7000	5300	4000										178
		0355	28000	18,0		17000	13500	11300	8700	6700												

WOLFFKRAN

Mietkrananfrage / enquiry for rental / Demande d'offre de location grue

Standort / Site / Site	Adresse / Adress / Adresse	Telefon / Fone / Téléphone	Telefax / Fax / Téléfax	E-Mail / www
WOLFFKRAN GmbH Deutschland	Austraße 72 74076 Heilbronn	+49 7131 9815-0	+49 7131 9815-355	info@wolffkran.de www.wolffkran.de
WOLFFKRAN Austria GmbH	Neubaugasse 5 2326 Lanzendorf	+43 2235 42021-0	+43 2235 42021-10	info@wolffkran.at www.wolffkran.at
WOLFFKRAN Schweiz AG	Buchserstrasse 25 8108 Dällikon ZH	+41 44 8476007	+41 44 8476001	info@wolffkran.ch www.wolffkran.ch
WOLFFKRAN LOKUS a.s. Czech Republic	Jeremiášova 947 155 00 Praha 5	+420 296 376 385		lokus@lokus.cz www.wolffkran-lokus.cz
WOLFFKRAN Norge AS Norway	Johan Follestadsvai 22 3474 Åros	+47 917 95 039		espen@wolffkran.no www.wolffkran.com
WOLFFKRAN Belgium BVBA	Industriezone Puursesteenweg Puursesteenweg 355 – b 0002 2880 Bornem (Antwerp)	+ 32 3 740 00 50	+ 32 3 740 00 59	info@wolffkran.be www.wolffkran.be
WOLFFKRAN SAS France	ZI d'Edpluches - Rue des Préaux 95310 Saint-Ouen-l'Aumône	+ 33 1 61 03 11 12		info@wolffkran.fr www.wolffkran.fr
WOLFFKRAN Ltd. United Kingdom	Grange Mill Lane Sheffield, S9 1HW	+44 1709 559 668	+44 1709 557 326	info@htcplant.com www.wolffkran.com
WOLFFKRAN Inc. USA	9231 Lambright Rd Houston, Houston Texas Branch TX 77075	+1 347 821 7655	+1 718 418 9656	info@wolffkran.com www.wolffkran.com
WOLFFKRAN Arabia LLC U.A.E	PO Box 48903 OFFICENO.1101,ICONTOWER,TECOMDubai	+971 4 369 7860	+9714 369 7861	info@wolffkranarabia.ae www.wolffkran.ae

**RENT A WOLFF!**

WOLFF

Turmkrane mit Laufkatzausleger

tower cranes with trolley jib

grue à tour à flèche horizontale



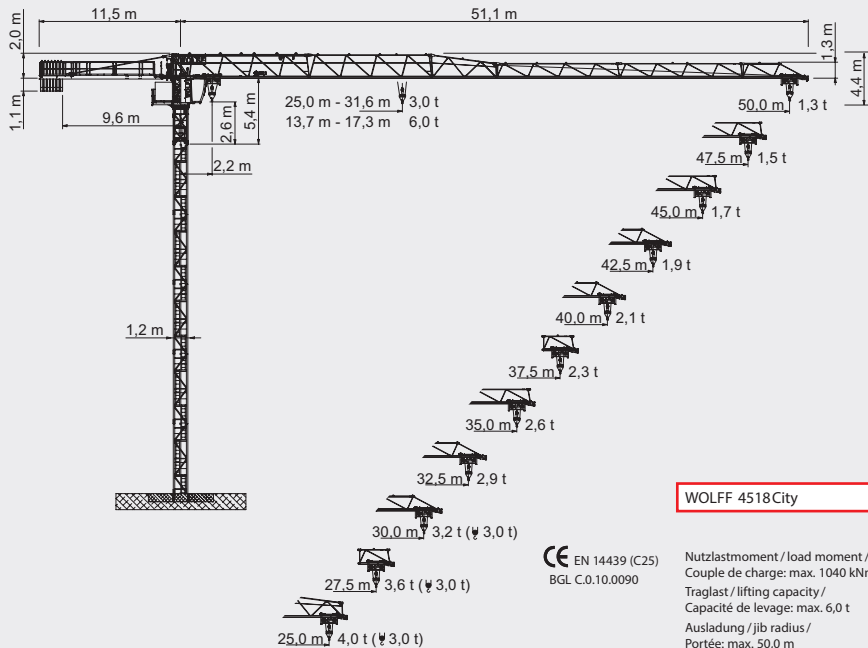

WOLFF 4518 City Turmkombinationen - Tower configurations - Combinaisons de tour

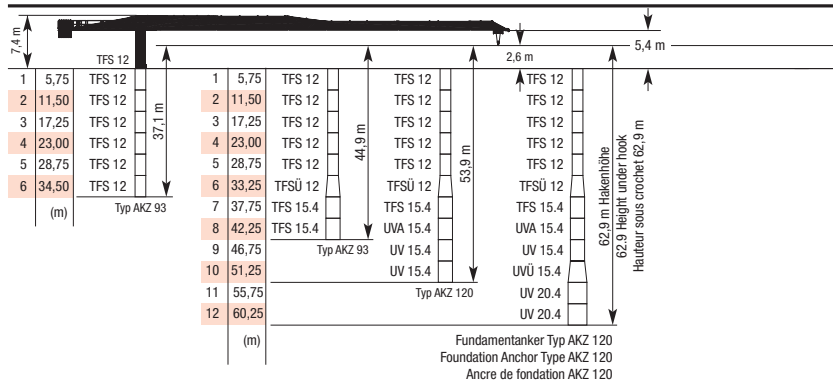



Weitere Standbasen auf Anfrage
 Further base frames on request
 Pour d'autres bases, nous consulter

Traglasten (t) · WOLFF 4518 City

Load Data





Charges

Ausladung (m) / jib radius (m) / Portée (m)		15	20	25	27,5	30	32,5	35	37,5	40	42,5	45	47,5	50			
Ausdehnlänge (m) jib length (m) / Longueur de flèche (m)	50,0	2,2 – 25,6	 3,0 t	3,0	3,0	3,0	2,8	2,5	2,3	2,1	1,9	1,8	1,6	1,5	1,4	1,3	
	47,5	2,2 – 27,0		3,0	3,0	3,0	2,9	2,7	2,4	2,2	2,0	1,9	1,7	1,6	1,5		
	45,0	2,2 – 28,2		3,0	3,0	3,0	3,0	2,8	2,5	2,3	2,1	2,0	1,8	1,7			
	42,5	2,2 – 29,1		3,0	3,0	3,0	3,0	2,9	2,6	2,4	2,2	2,1	1,9				
	40,0	2,2 – 29,7		3,0	3,0	3,0	3,0	3,0	2,7	2,5	2,3	2,1					
	37,5	2,2 – 30,0		3,0	3,0	3,0	3,0	3,0	2,7	2,5	2,3						
	35,0	2,2 – 31,0		3,0	3,0	3,0	3,0	3,0	2,8	2,6							
	32,5	2,2 – 31,6		3,0	3,0	3,0	3,0	3,0	2,9								
	30,0	2,2 – 30,0		3,0	3,0	3,0	3,0	3,0									
	27,5	2,2 – 27,5		3,0	3,0	3,0	3,0										
25,0	2,2 – 25,0	3,0	3,0	3,0													
Ausladung (m) / jib radius (m) / Portée (m)		15	20	25	27,5	30	32,5	35	37,5	40	42,5	45	47,5	50			
Ausdehnlänge (m) jib length (m) / Longueur de flèche (m)	50,0	2,2 – 13,7	 6,0 t	5,5	4,0	3,1	2,8	2,5	2,3	2,1	1,9	1,8	1,6	1,5	1,4	1,3	
	47,5	2,2 – 14,5		5,8	4,2	3,3	2,9	2,7	2,4	2,2	2,0	1,9	1,7	1,6	1,5		
	45,0	2,2 – 15,1		6,0	4,4	3,4	3,1	2,8	2,5	2,3	2,1	2,0	1,8	1,7			
	42,5	2,2 – 15,6		6,0	4,6	3,6	3,2	2,9	2,6	2,4	2,2	2,1	1,9				
	40,0	2,2 – 15,9		6,0	4,7	3,7	3,3	3,0	2,7	2,5	2,3	2,1					
	37,5	2,2 – 16,1		6,0	4,7	3,7	3,3	3,0	2,7	2,5	2,3						
	35,0	2,2 – 16,6		6,0	4,9	3,8	3,4	3,1	2,8	2,6							
	32,5	2,2 – 17,0		6,0	5,0	3,9	3,5	3,2	2,9								
	30,0	2,2 – 17,0		6,0	5,0	3,9	3,5	3,2									
	27,5	2,2 – 17,3		6,0	5,1	4,0	3,6										
25,0	2,2 – 17,3	6,0	5,1	4,0													















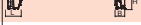

Antriebe · WOLFF 4518 City · (Hw 318 FU)

Mechanisms

Mécanismes

					
Motor (kW) motor Moteur	18,5	18,5	4,0	1 x 4,0	2 x 5,5
Geschwindigkeit speed Vitesse	0 – 1,5 t 0...55 m/min stufenlos/ stepless/ en continue 0 – 3,0 t 0...30 m/min	0 – 3,2 t 0...27 m/min stufenlos/ stepless/ en continue 0 – 6,0 t 0...15 m/min	0 – 3,0 t 0...70 m/min stufenlos/ stepless/ en continue 0 – 6,0 t 0...50 m/min	0,8 min ⁻¹	25,0 m/min
Hakenweg (m) hook path course du crochet	100	50			

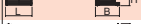
WOLFF 4518 City Kollifliste - Colli list - Liste de colisage

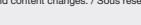
Pos. Pos.	Stk. Pcs. Pos.	Beschreibung / Description / Description	Kollif / Colli / Collis	L (m) Length Longueur	B (m) Width Largeur	H (m) Height Hauteur	Gewicht (kg) Weight Poids	Volumen (m³) Volume Volume
1	1	Turmspitze komplett / Tower top complete / Pointe de tour complète		5,38	1,66	1,41	3460	12,59
	1	Verbindungsturmstück / Connection tower element / Élément d'axe pour grue <small>Pos. 1 zerlegt / Item 1 disassembled / Pos. 1 groupe</small>		1,98	1,02	1,41	810	2,85
	1	Turmspitzenunterteil / Tower top lower part / Pivot tournant <small>Pos. 1 zerlegt / Item 1 disassembled / Pos. 1 groupe</small>		4,53	1,66	1,41	2650	10,60
2	1	Schaltschrankstation / Control cabinet platform / Station de l'armoire électrique <small>mit Schaltschrank / with control cabinet / avec armoire de distribution</small>		3,12	1,77	1,91	1025	10,55
3	1	Führerhaus (Option) / Operator cabin (option) / Cabine du grutier (option) <small>Alternativ: Funkfernsteuerung / As an alternative: radio remote control / Alternatif: Télécommande radio</small>		2,16	1,46	2,34	940	7,38
4	1	Gegenausleger / Counterjib / Contre-fleche <small>mit Auslegerarm und Plattform / with jib arm and platform / avec éléments de hauberge et plateforme</small>		10,17	1,60	0,52	2425	8,46
5	1	Auslegerteil 1 / Jib part 1 / Élément de flèche 1 <small>inkl. Kätzchenwerk und Hubwerk / incl. trolley gear and hoisting gear / avec mécanisme de roulement du chariot et mécanisme de levage</small>		11,98	0,99	2,27	3135	26,92
6	1	Auslegerteil 2 / Jib part 2 / Élément de flèche 2		10,19	0,82	2,00	990	16,71
7	1	Auslegerteil 3 / Jib part 3 / Élément de flèche 3		5,47	0,82	1,95	435	8,75
8	1	Auslegerteil 4 / Jib part 4 / Élément de flèche 4		10,18	0,82	1,30	695	10,85
9	1	Auslegerteil 5 / Jib part 5 / Élément de flèche 5		2,66	0,82	1,30	200	2,84
10	1	Auslegerteil 6 / Jib part 6 / Élément de flèche 6		10,16	0,82	1,30	605	10,83
11	1	Auslegerteil 7 / Jib part 7 / Élément de flèche 7		5,15	0,82	1,30	270	5,49
12	1	Seilwibeltraverse / Rope swivel traverse / Traverse de pointe fixe		0,79	0,75	0,43	60	0,25
13	1	Laufkatze LK 3/6 / Trolley LK 3/6 / Chariot de distribution LK 3/6		1,58	1,07	0,80	200	1,35
14	1	Wartungskorb / Service cage / Nacelle de transport de personne		0,75	0,50	2,05	55	0,77
15		Normgeländer / Standard railings / Garde-corps		1,10	2,55	1,05	332	2,95
16	1	Unterflasche U 3/6 / Hook block U 3/6 / Crochet U 3/6		0,72	0,21	1,40	240	0,21
17		Gegengewichtssteine / Counterweight blocks / Blocs de contrepoids		1,60	0,23	2,38	1800	0,88

Technische und inhaltliche Änderungen vorbehalten / All rights reserved regarding technical and content changes. / Sous réserve de modifications techniques et de fond.

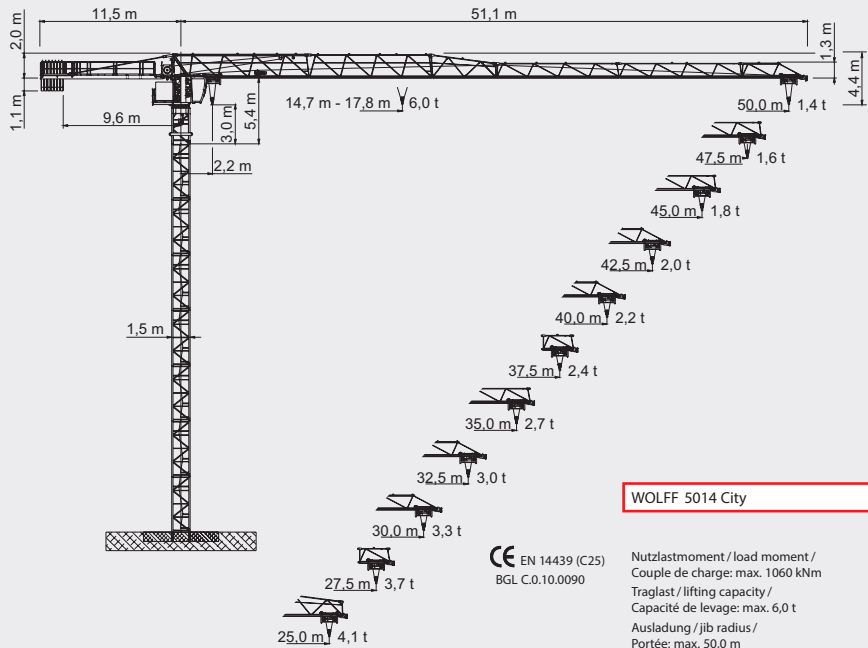

WOLFF 5014 City Turmkombinationen - Tower configurations - Combinaisons de tour

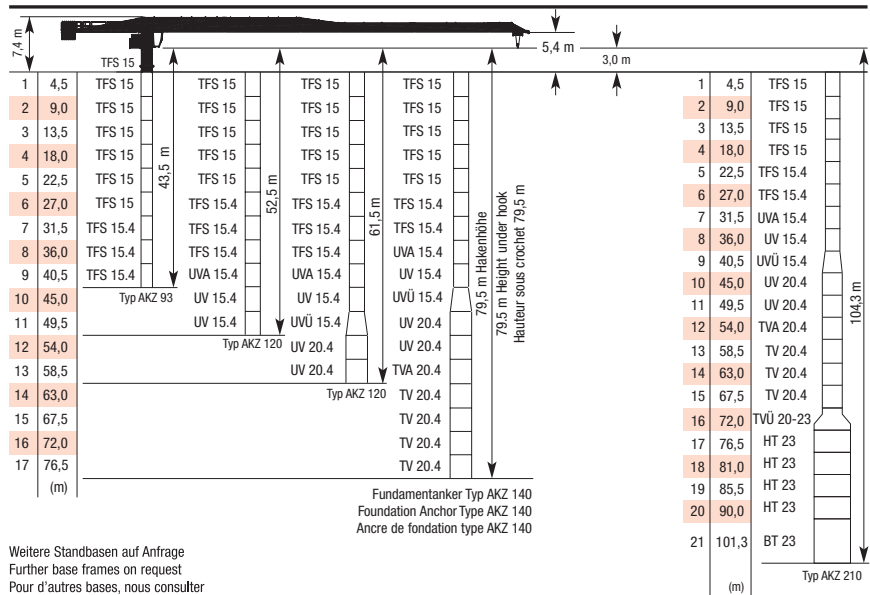

Traglasten (t) · WOLFF 5014 City

Load Data





Charges

Ausladung (m)/ jib radius (m) / Portée (m)			25,0	27,5	30,0	32,5	35,0	37,5	40,0	42,5	45,0	47,5	50,0		
Auslegerlänge (m) / jib length (m) / Longueur de flèche (m)	50,0	2,2 - 14,7	 6,0 t	3,3	3,0	2,7	2,4	2,2	2,0	1,9	1,7	1,6	1,5	1,4	Tragfähigkeit (t) / load capacity (t) / Capacité de charge (t)
	47,5	2,2 - 15,4		3,5	3,1	2,8	2,6	2,4	2,2	2,0	1,9	1,7	1,6		
	45,0	2,2 - 16,0		3,7	3,3	3,0	2,7	2,5	2,3	2,1	1,9	1,8			
	42,5	2,2 - 16,4		3,8	3,4	3,1	2,8	2,5	2,3	2,2	2,0				
	40,0	2,2 - 16,7		3,8	3,4	3,1	2,8	2,6	2,4	2,2					
	37,5	2,2 - 16,8		3,9	3,5	3,1	2,9	2,6	2,4						
	35,0	2,2 - 17,3		4,0	3,6	3,2	3,0	2,7							
	32,5	2,2 - 17,5		4,1	3,6	3,3	3,0								
	30,0	2,2 - 17,6		4,1	3,7	3,3									
	27,5	2,2 - 17,8		4,1	3,7										
	25,0	2,2 - 17,7		4,1											





















Antriebe · WOLFF 5014 City · (Hw 628.1 FU)

Mechanisms

Mécanismes

				
Motor (kW) motor Moteur	28	4,0	1 x 4,0	2 x 5,5
Geschwindigkeit speed Vitesse	0 - 1,1 t 0...108 m/min stufenlos / stepless / en continue 0 - 6,0 t 0...24 m/min	0 - 3,0 t 0...70 m/min stufenlos / stepless / en continue 0 - 6,0 t 0...50 m/min	0,8 min ⁻¹	25,0 m/min
Hakenweg (m) hook path course du crochet	190			

WOLFF 5014 City Kollifliste - Colli list - Liste de colisage

Pos. Pos. Pos.	Stk. Pos. Pos.	Beschreibung / Description / Description	Kolli / Colli / Colis	L (m) Length Longueur	B (m) Width Largeur	H (m) Height Hauteur	Gewicht (kg) Weight Poids	Volumen (m³) Volume Volume
1	1	Turmspitze komplett / Tower top complete / Pointe de tour complète		5,38	1,92	1,76	4105	18,18
	1	Verbindungsturmstück / Connection tower element / Élément d'axe pour grue <small>Pos. 1 zerlegt / Item 1 disassembled / Pos. 1 groupé</small>		1,98	1,02	1,41	810	2,85
	1	Turmspitzenunterteil / Tower top lower part / Pivot tournant <small>Pos. 1 zerlegt / Item 1 disassembled / Pos. 1 groupé</small>		4,53	1,92	1,76	3295	15,31
2	1	Schalterschrankstation / Control cabinet platform / Station de l'armoire électrique <small>mit Schaltkasten / with control cabinet / avec armoire de distribution</small>		3,12	1,77	1,91	1025	10,55
3	1	Führerhaus (Option) / Operator cabin (option) / Cabine du grutier (option) <small>Alternativ: Parkbremseanlage / As an alternative: radio remote control / Alternatif: Télécommande radio</small>		2,16	1,46	2,34	940	7,38
4	1	Gegenausleger / Counterjib / Contre-flèche <small>mit Abgrenztafel und Podest / with stop parts and platform / avec éléments de haubrage et plateformes</small>		10,17	1,60	0,52	2425	8,46
5	1	Hw 628.1 FU Hubwinde / Hoisting gear / Treuil de levage <small>mit Hubseil / with hoist rope / avec le câble de levage (MSD in = 325 kg) ohne 2. Bremsseil / without 2nd brake / sans 2ème frein</small>		1,86	0,84	0,82	1605	1,28
6	1	Auslegerteil 1 / Jib part 1 / Élément de flèche 1 <small>mit Kettentraverse und Hubwerk / incl. trussing gear and hoisting gear / avec mécanisme de roulement du chariot et mécanisme de levage</small>		12,04	1,88	2,17	4065	49,12
7	1	Auslegerteil 2 / Jib part 2 / Élément de flèche 2		10,19	0,82	2,00	990	16,71
8	1	Auslegerteil 3 / Jib part 3 / Élément de flèche 3		5,47	0,82	1,95	435	8,75
9	1	Auslegerteil 4 / Jib part 4 / Élément de flèche 4		10,18	0,82	1,30	695	10,85
10	1	Auslegerteil 5 / Jib part 5 / Élément de flèche 5		2,66	0,82	1,30	200	2,84
11	1	Auslegerteil 6 / Jib part 6 / Élément de flèche 6		10,16	0,82	1,30	605	10,83
12	1	Auslegerteil 7 / Jib part 7 / Élément de flèche 7		5,15	0,82	1,30	270	5,49
13	1	Seilwirbeltraverse / Rope swivel traverse / Traverse de pointe fixe		0,79	0,75	0,43	60	0,25
14	1	Laufkatze LK 6 / Trolley LK 6 / Chariot de distribution LK 6		1,57	1,07	0,92	185	1,55
15	1	Wartungskorb / Service cage / Nacelle de transport de personne		0,75	0,50	2,05	55	0,77
16		Normgeländer / Standard railings / Garde-corps		1,10	2,55	1,05	332	2,95
17	1	Unterflasche U 6 / Hook block U 6 / Crochet U 6		0,40	0,34	0,87	225	0,12
18	7	Gegengewichtssteine / Counterweight blocks / Blocs de contrepoids		1,60	0,23	2,38	1800	0,88

Technische und inhaltliche Änderungen vorbehalten / All rights reserved regarding technical and content changes. / Sous réserve de modifications techniques et de fond.

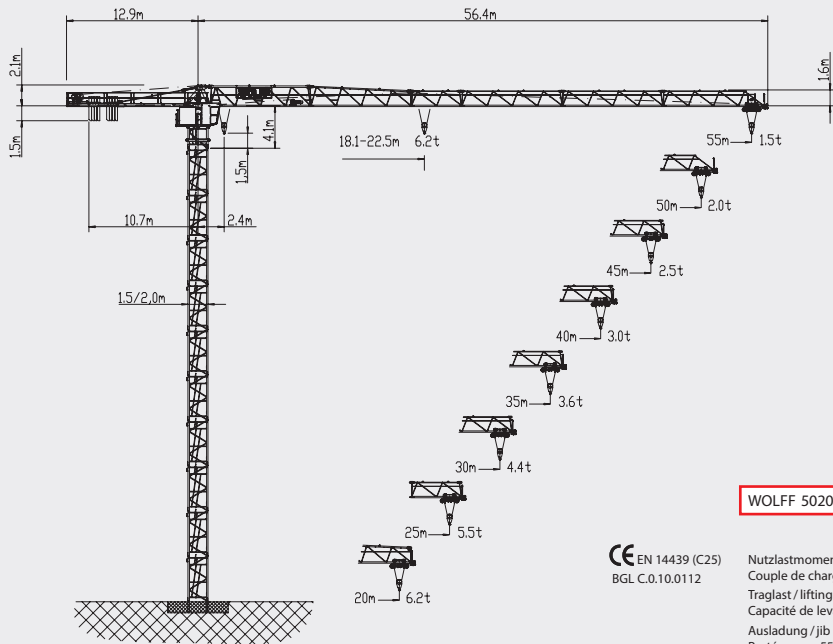

WOLFF 5020.6 Clear

CE EN 14439 (C25)
BGL C.0.10.0112

Nutzlastmoment / load moment /
Couple de charge: max. 1400 kNm
Traglast / lifting capacity /
Capacité de levage: max. 6,2 t
Ausladung / jib radius /
Portée: max. 55,0 m



WOLFF 5020 Clear Turmkombinationen - Tower configurations - Combinaisons de tour

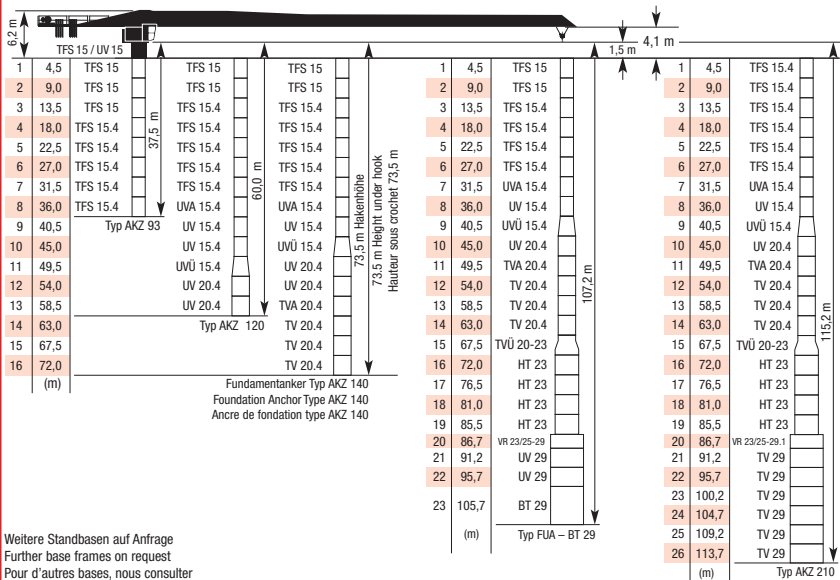

WOLFF 5020 Clear Turmkombinationen - Tower configurations - Combinaisons de tour

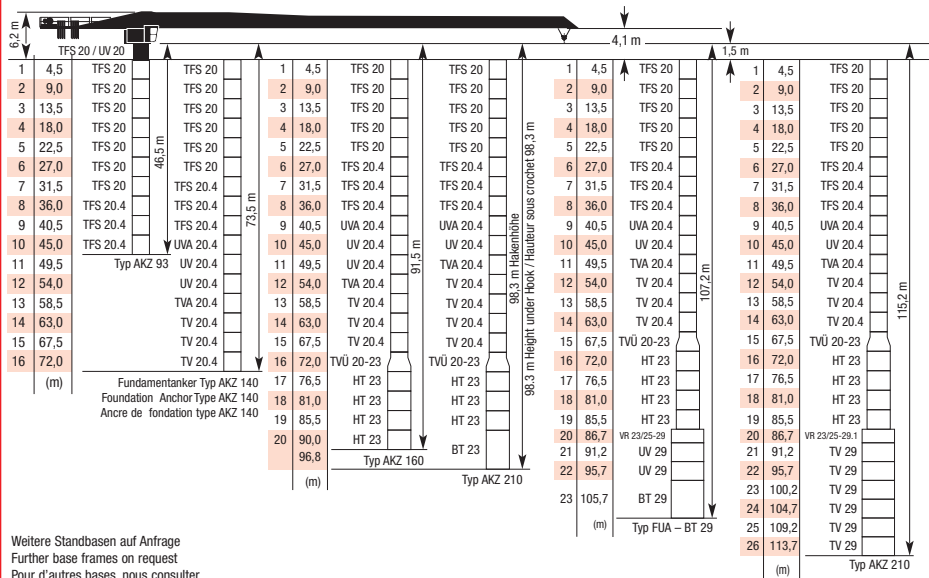

Weitere Standbasen auf Anfrage
Further base frames on request
Pour d'autres bases, nous consulter

Traglasten (t) - WOLFF 5020.6 Clear

Load Data

Charges



Ausladung (m) / jib radius (m) / Portée (m)		15	20	22,5	25	27,5	30	32,5	35	37,5	40	42,5	45	47,5	50	52,5	55		
Auslegertänge (m) / jib length (m) / Longueur de flèche (m)	55,0	2,4 – 18,1	 6,2 t	6,2	5,5	4,8	4,3	3,8	3,4	3,1	2,8	2,6	2,4	2,2	2,0	1,9	1,7	1,6	1,5
	52,5	2,4 – 19,5		6,2	6,0	5,3	4,7	4,2	3,8	3,4	3,1	2,8	2,6	2,4	2,2	2,1	1,9	1,8	
	50,0	2,4 – 20,0		6,2	6,2	5,4	4,8	4,3	3,9	3,5	3,2	2,9	2,7	2,5	2,3	2,1	2,0		
	47,5	2,4 – 20,4		6,2	6,2	5,5	4,9	4,4	4,0	3,6	3,3	3,0	2,8	2,6	2,4	2,2			
	45,0	2,4 – 21,2		6,2	6,2	5,8	5,1	4,6	4,2	3,8	3,4	3,2	2,9	2,7	2,5				
	42,5	2,4 – 21,3		6,2	6,2	5,8	5,2	4,6	4,2	3,8	3,5	3,2	2,9	2,7					
	40,0	2,4 – 21,7		6,2	6,2	6,0	5,3	4,7	4,3	3,9	3,5	3,3	3,0						
	37,5	2,4 – 22,0		6,2	6,2	6,0	5,4	4,8	4,3	3,9	3,6	3,3							
	35,0	2,4 – 22,0		6,2	6,2	6,0	5,4	4,8	4,3	3,9	3,6								
	32,5	2,4 – 22,3		6,2	6,2	6,1	5,4	4,9	4,4	4,0									
	30,0	2,4 – 22,3		6,2	6,2	6,1	5,4	4,9	4,4										
	27,5	2,4 – 22,4		6,2	6,2	6,2	5,5	4,9											
	25,0	2,4 – 22,5		6,2	6,2	6,2	5,5												
	22,5	2,4 – 22,5		6,2	6,2	6,2													
	20,0	2,4 – 20,0		6,2	6,2														

Tragfähigkeit (t) / load capacity (t) / Capacité de charge (t)





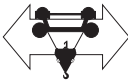













Antriebe · WOLFF 5020.6 Clear · (Hw 628 FU)

Mechanisms

Mécanismes

				
Motor (kW) motor Moteur	28	4,0	7,5	2 x 5,5
Geschwindigkeit speed Vitesse	0 – 2,5 t 0...52 m/min stufenlos/ stepless/ en continue 0 – 6,2 t 0...23 m/min	0 – 2,0 t 0...80 m/min stufenlos/ stepless/ en continue 0 – 6,2 t 0...50 m/min	0,80 min ⁻¹	25,0 m/min
Hakenweg (m) hook path course du crochet	190			

WOLFF 5020.6 Clear Kollif Liste - Colli List - Liste de colisage

Pos. Pos. Pos.	Stck. Pce. Pcs.	Beschreibung / Description / Description	Kollif / Colli / Coils	L (m) Length Longueur	B (m) Width Largeur	H (m) Height Hauteur	Gewicht (kg) Weight Poids	Volumen (m³) Volume Volume
1	1	Turmspitze komplett / Tower top complete / Pointe de tour complète		6,16	2,10	1,98	5750	25,61
				6,16	2,10	2,42	5820	31,31
		Turmspitzenoberteil / Tower top upper part / Porte-flèche <small>Pos. 1 zerlegt / Item 1 disassembled / Pos. 1 groupe</small>		1,87	0,36	1,85	890	1,25
			Turmspitzenunterteil / Tower top lower part / Pivot tournant <small>Pos. 1 zerlegt / Item 1 disassembled / Pos. 1 groupe</small>		5,52	2,10	1,98	4860
		5,52		2,10	2,42	4930	28,05	
2	1	Führerhaus mit Aufhängung / Driver's cabin with suspension / Cabine avec fixation		4,82	2,12	2,55	2610	26,06
3	1	Gegenausleger komplett / Counterjib complete / Contre-flèche complète		12,00	2,30	0,64	4410	17,66
4	1	Hw 628 FU Hubwindenplattform / Hoisting platform / Plateforme de levage sans armoir électrique		2,17	1,50	1,12	2175	3,65
5	1	Kiste (Kleinteile) / Box (small parts) / Caisse à outils		0,63	0,50	0,38	100	1,12
6	1	Normgeländer / Standard handrail / Garde-corps		2,60	1,10	0,65	220	1,86
7	1	Auslegerteil 1 / Jib part 1 / Élément de flèche 1		10,29	1,19	2,30	2330	28,41
8	1	Auslegerteil 3 / Jib part 3 / Élément de flèche 3		10,27	1,19	2,08	1310	25,42
9	1	Auslegerteil 4 / Jib part 4 / Élément de flèche 4		5,25	1,19	1,65	645	10,31
10	1	Auslegerteil 5 / Jib part 5 / Élément de flèche 5		2,75	1,19	1,65	395	5,40
11	1	Auslegerteil 6 / Jib part 6 / Élément de flèche 6		10,23	1,19	1,65	1010	20,08
12	1	Auslegerteil 7 / Jib part 7 / Élément de flèche 7		10,21	1,19	1,64	810	20,05
13	1	Auslegerteil 8 / Jib part 8 / Élément de flèche 8		10,17	1,19	1,64	705	19,87
14	1	Seilwirbeltraverse / Rope swivel traverse / Traverse de pointe fixe		0,89	1,10	0,45	105	0,44
15	1	Laufkatze LK 8 / Trolley LK 8 / Chariot de distribution LK 8		1,87	1,42	0,95	295	2,52
16	1	Wartungskorb LK 8 / Service cage LK 8 / Nacelle de transport de personne LK 8		0,75	0,58	1,69	55	0,74
17	1	Unterflasche U 6 (8) / Hook block U 6 (8) / Crochet U 6 (8)		0,50	0,22	1,11	350	0,12

Technische und inhaltliche Änderungen sind vorbehalten. / All rights reserved regarding technical and content changes. / Sous réserve de modifications techniques et de fond.

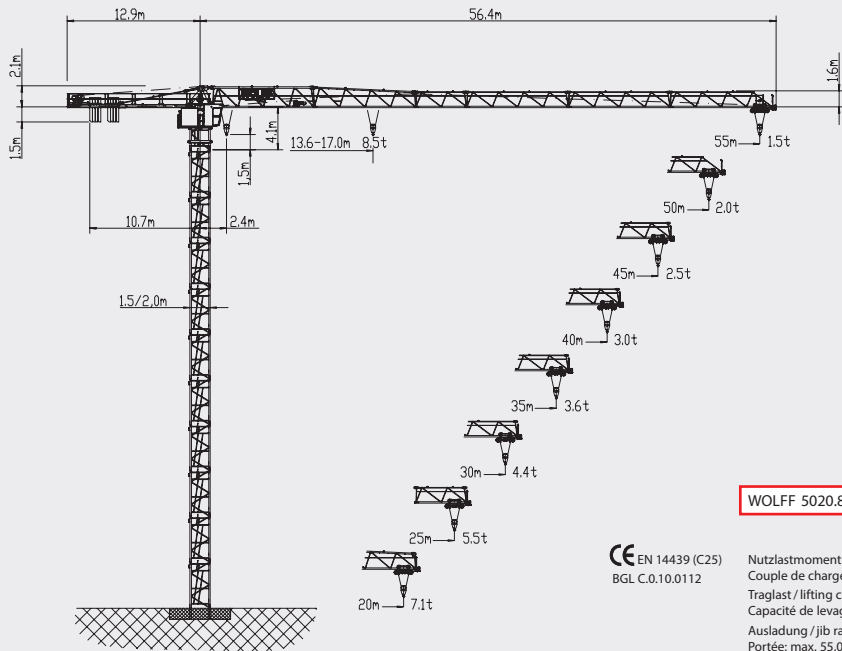

WOLFF 5020.8 Clear

CE EN 14439 (C25)
BGL C.0.10.0112

Nutzlastmoment / load moment /
Couple de charge: max. 1440 kNm
Traglast / lifting capacity /
Capacité de levage: max. 8,5 t
Ausladung / jib radius /
Portée: max. 55,0 m



WOLFF 5020 Clear Turmkombinationen - Tower configurations - Combinaisons de tour

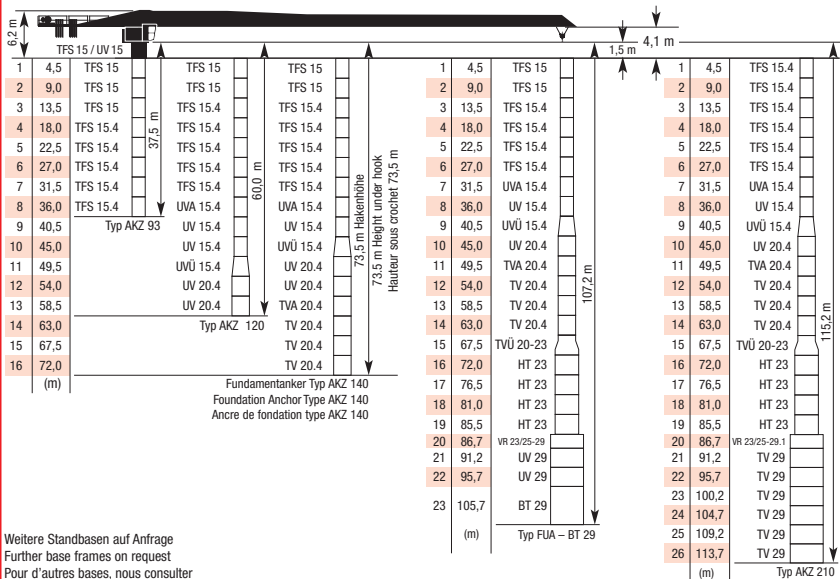

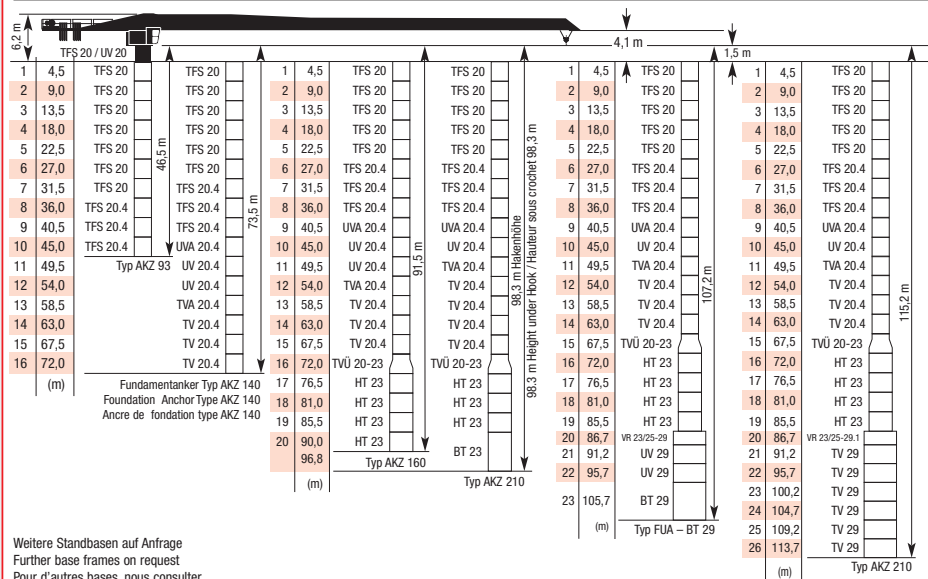
WOLFF 5020 Clear Turmkombinationen - Tower configurations - Combinaisons de tour

Traglasten (t) - WOLFF 5020.8 Clear

Load Data

Charges

Ausladung (m) / jib radius (m) / Portée (m)		15	20	22,5	25	27,5	30	32,5	35	37,5	40	42,5	45	47,5	50	52,5	55	
Auslegertänge (m) / jib length (m) / Longueur de flèche (m)	55,0	2,4 – 13,6	7,6	5,5	4,8	4,3	3,8	3,4	3,1	2,8	2,6	2,4	2,2	2,0	1,9	1,7	1,6	1,5
	52,5	2,4 – 14,7	8,3	6,0	5,3	4,7	4,2	3,8	3,4	3,1	2,8	2,6	2,4	2,2	2,1	1,9	1,8	
	50,0	2,4 – 15,1	8,5	6,2	5,4	4,8	4,3	3,9	3,5	3,2	2,9	2,7	2,5	2,3	2,1	2,0		
	47,5	2,4 – 15,3	8,5	6,3	5,5	4,9	4,4	4,0	3,6	3,3	3,0	2,8	2,6	2,4	2,2			
	45,0	2,4 – 16,0	8,5	6,6	5,8	5,1	4,6	4,2	3,8	3,4	3,2	2,9	2,7	2,5				
	42,5	2,4 – 16,0	8,5	6,6	5,8	5,2	4,6	4,2	3,8	3,5	3,2	2,9	2,7					
	40,0	2,4 – 16,3	8,5	6,8	6,0	5,3	4,7	4,3	3,9	3,5	3,3	3,0						
	37,5	2,4 – 16,5	8,5	6,9	6,0	5,4	4,8	4,3	3,9	3,6	3,3							
	35,0	2,4 – 16,6	8,5	6,9	6,0	5,4	4,8	4,3	3,9	3,6								
	32,5	2,4 – 16,8	8,5	7,0	6,1	5,4	4,9	4,4	4,0									
	30,0	2,4 – 16,8	8,5	7,0	6,1	5,4	4,9	4,4										
	27,5	2,4 – 16,9	8,5	7,0	6,2	5,5	4,9											
	25,0	2,4 – 16,9	8,5	7,1	6,2	5,5												
	22,5	2,4 – 16,9	8,5	7,1	6,2													
	20,0	2,4 – 17,0	8,5	7,1														







8,5 t

Tragfähigkeit (t) / load capacity (t) / Capacité de charge (t)



















Antriebe · WOLFF 5020.8 Clear · (Hw 845 FU)

Mechanisms

Mécanismes

				
Motor (kW) motor Moteur	45	4,0	7,5	2 x 5,5
Geschwindigkeit speed Vitesse	0 – 1,6 t 0...115 m/min stufenlos/ stepless/ en continue 0 – 8,5 t 0...26 m/min	0 – 2,0 t 0...80 m/min stufenlos/ stepless/ en continue 0 – 8,5 t 0...20 m/min	0,80 min ⁻¹	25,0 m/min
Hakenweg (m) hook path course du crochet	190			

WOLFF 5020.8 Clear Kollif Liste - Colli List - Liste de colisage

Pos. Pos. Pos.	Stck. Pce. Pcs.	Beschreibung / Description / Description	Kollif / Colli / Coils	L (m) Length Longueur	B (m) Width Largeur	H (m) Height Hauteur	Gewicht (kg) Weight Poids	Volumen (m³) Volume Volume
1	1	Turmspitze komplett / Tower top complete / Pointe de tour complète		6,16	2,10	1,98	TFS 15 / UV 15 5750	25,61
				6,16	2,10	2,42	TFS 20 / UV 20 5820	31,31
		Turmspitzenoberteil / Tower top upper part / Porte-flèche <small>Pos. 1 zerlegt / Item 1 disassembled / Pos. 1 groupe</small>		1,87	0,36	1,85	890	1,25
			Turmspitzenunterteil / Tower top lower part / Pivot tournant <small>Pos. 1 zerlegt / Item 1 disassembled / Pos. 1 groupe</small>		5,52	2,10	1,98	TFS 15 / UV 15 4860
	5,52	2,10		2,42	TFS 20 / UV 20 4930	28,05		
2	1	Führerhaus mit Aufhängung / Driver's cabin with suspension / Cabine avec fixation		4,82	2,12	2,55	2610	26,06
3	1	Gegenausleger komplett / Counterjib complete / Contre-flèche complète		12,00	2,30	0,64	4410	17,66
4	1	Hw 628 FU Hubwindenplattform / Hoisting platform / Plateforme de levage sans armoir électrique		2,17	1,57	1,04	2140	3,54
5	1	Kiste (Kleinteile) / Box (small parts) / Caisse à outils		0,63	0,50	0,38	100	1,12
6	1	Normgeländer / Standard handrail / Garde-corps		2,60	1,10	0,65	220	1,86
7	1	Auslegerteil 1 / Jib part 1 / Élément de flèche 1		10,29	1,19	2,30	2330	28,41
8	1	Auslegerteil 3 / Jib part 3 / Élément de flèche 3		10,27	1,19	2,08	1310	25,42
9	1	Auslegerteil 4 / Jib part 4 / Élément de flèche 4		5,25	1,19	1,65	645	10,31
10	1	Auslegerteil 5 / Jib part 5 / Élément de flèche 5		2,75	1,19	1,65	395	5,40
11	1	Auslegerteil 6 / Jib part 6 / Élément de flèche 6		10,23	1,19	1,65	1010	20,08
12	1	Auslegerteil 7 / Jib part 7 / Élément de flèche 7		10,21	1,19	1,64	810	20,05
13	1	Auslegerteil 8 / Jib part 8 / Élément de flèche 8		10,17	1,19	1,64	705	19,87
14	1	Seilwirbeltraverse / Rope swivel traverse / Traverse de pointe fixe		0,89	1,10	0,45	105	0,44
15	1	Laufkatze LK 8 / Trolley LK 8 / Chariot de distribution LK 8		1,87	1,42	0,95	295	2,52
16	1	Wartungskorb LK 8 / Service cage LK 8 / Nacelle de transport de personne LK 8		0,75	0,58	1,69	55	0,74
17	1	Unterflasche U 6 (8) / Hook block U 6 (8) / Crochet U 6 (8)		0,50	0,22	1,11	350	0,12

Technische und inhaltliche Änderungen sind vorbehalten. / All rights reserved regarding technical and content changes. / Sous réserve de modifications techniques et de fond.

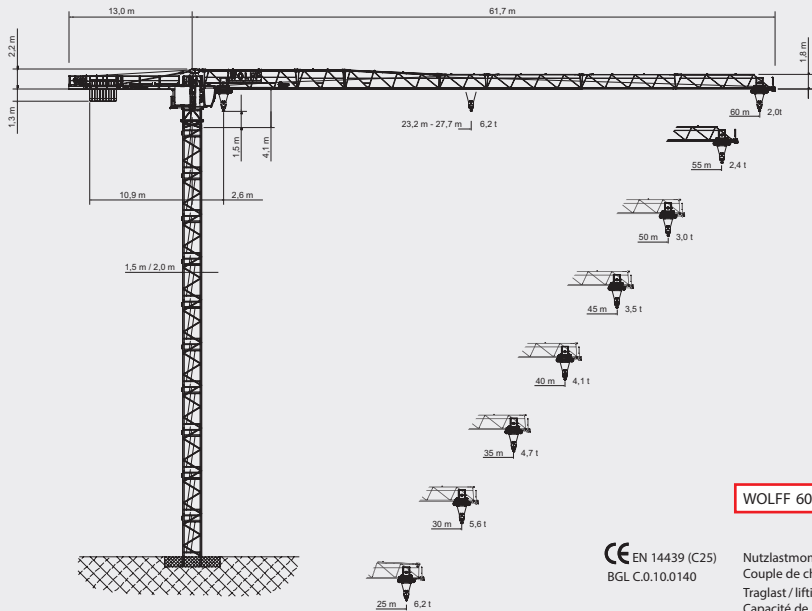

WOLFF 6020.6 Clear

CE EN 14439 (C25)
BGL C.0.10.0140

Nutzlastmoment / load moment /
Couple de charge: max. 1720 kNm
Traglast / lifting capacity /
Capacité de levage: max. 6,2 t
Ausladung / jib radius /
Portée: max. 60,0 m



WOLFF 6020 Clear Turmkombinationen - Tower configurations - Combinaisons de tour

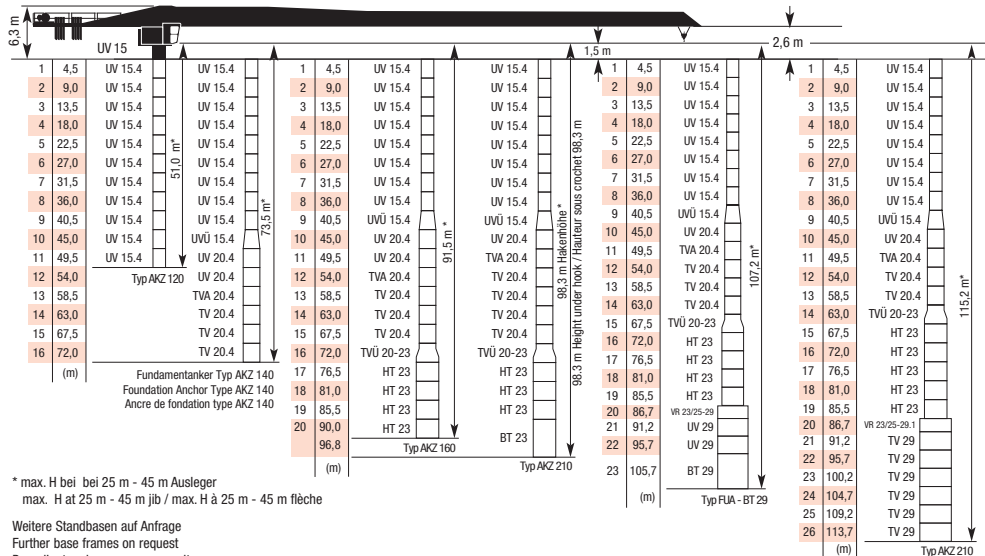

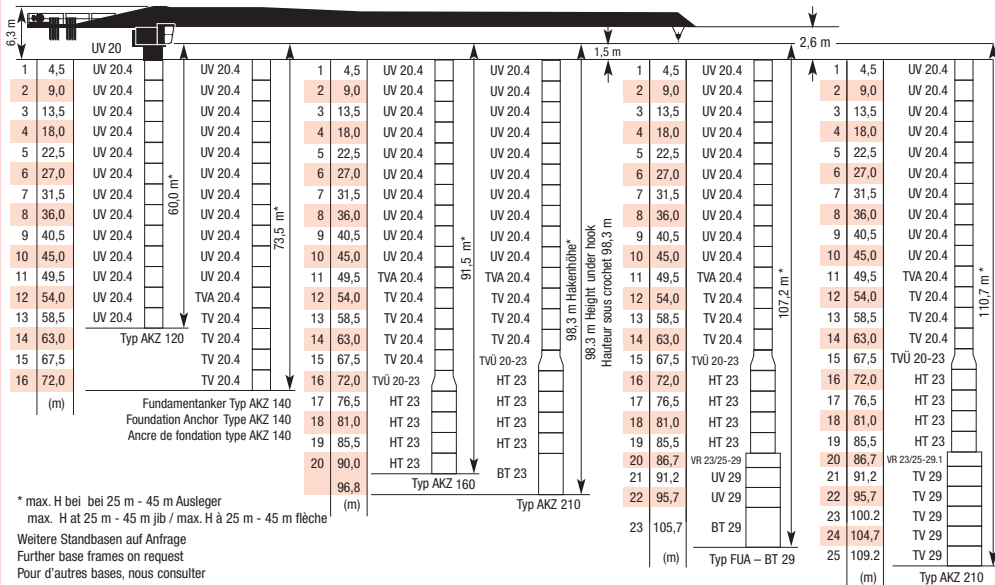
WOLFF 6020 Clear Turmkombinationen · Tower configurations · Combinaisons de tour

Traglasten [t] · WOLFF 6020.6 Clear
Load Data
Charges

Ausladung / jib radius / Portée [m]			20,0	22,5	25,0	27,5	30,0	32,5	35,0	37,5	40,0	42,5	45,0	47,5	50,0	52,5	55,0	57,5	60,0
Ausleglänge / jib length / Longueur de flèche [m]	60,0	2,6 - 23,2	6,2	6,2	5,7	5,1	4,7	4,2	3,9	3,6	3,3	3,1	2,9	2,7	2,5	2,4	2,2	2,1	2,0
	57,5	2,6 - 23,9	6,2	6,2	5,9	5,3	4,8	4,4	4,0	3,7	3,4	3,2	3,0	2,8	2,6	2,5	2,3	2,2	
	55,0	2,6 - 24,5	6,2	6,2	6,1	5,5	4,9	4,5	4,1	3,8	3,5	3,3	3,1	2,9	2,7	2,6	2,4		
	52,5	2,6 - 24,9	6,2	6,2	6,2	5,6	5,0	4,6	4,2	3,9	3,6	3,4	3,1	2,9	2,8	2,6			
	50,0	2,6 - 26,6	6,2	6,2	6,2	6,0	5,4	5,0	4,6	4,2	3,9	3,6	3,4	3,2	3,0				
	47,5	2,6 - 26,7	6,2	6,2	6,2	6,0	5,4	5,0	4,6	4,2	3,9	3,7	3,4	3,2					
	45,0	2,6 - 27,2	6,2	6,2	6,2	6,1	5,6	5,1	4,7	4,3	4,0	3,7	3,5						
	42,5	2,6 - 27,6	6,2	6,2	6,2	6,2	5,7	5,2	4,8	4,4	4,1	3,8							
	40,0	2,6 - 27,7	6,2	6,2	6,2	6,2	5,7	5,2	4,8	4,4	4,1								
	37,5	2,6 - 27,6	6,2	6,2	6,2	6,2	5,7	5,2	4,8	4,4									
	35,0	2,6 - 27,3	6,2	6,2	6,2	6,2	5,6	5,1	4,7										
	32,5	2,6 - 27,3	6,2	6,2	6,2	6,1	5,6	5,1											
	30,0	2,6 - 27,4	6,2	6,2	6,2	6,2	5,6												
	27,5	2,6 - 27,5	6,2	6,2	6,2	6,2													
	25,0	2,6 - 25,0	6,2	6,2	6,2														







6,2 t

Tragfähigkeit / load capacity / Capacité de charge [t]

























Antriebe · WOLFF 6020.6 Clear · (Hw 628.1 FU)

Mechanisms

Mécanismes

				
Motor [kW] motor Moteur	28	7,5	7,5	2 x 5,5
Geschwindigkeit speed Vitesse	0 - 1,1 t 0 ... 108 m/min stufenlos / stepless / en continue 0 - 6,2 t 0 ... 23 m/min	0 - 3,0 t 0 ... 100 m/min stufenlos / stepless / en continue 0 - 6,2 t 0 ... 78 m/min	0,80 min ⁻¹	25,0 m/min
Hakenweg [m] hook path course du crochet	190			

WOLFF 6020.6 Clear Kollif Liste - Colli List - Liste de colisage

Pos. Pos. Pos.	Stck. Pcs. Pcs.	Beschreibung / Description / Description	Kolli / Colli / Collis	L [m] Length Longueur	B [m] Width Largeur	H [m] Height Hauteur	Gewicht [kg] Weight Poids	Volumen [m³] Volume Volume
1	1	Turmspitze komplett / Tower top complete / Pointe de tour complète mit Abwehrtellen und Gelländer / with stay parts and standard handrail / avec éléments de haubannage et garde-corps		6,30	2,30	UV 20 2,42	7290	35,07
				6,30	2,30	TFS 20 2,42	6770	35,07
	1	Turmspitzenoberteil / Tower top upper part / Porte-fleche Pos. 1 zerlegt / Item 1 disassembled / Pos. 1 groupe mit Abwehrtellen / with stay parts / avec éléments de haubannage		6,30	2,30	UV 15 2,42	7220	35,07
				2,19	0,66	1,84	960	2,66
	1	Turmspitzenunterteil / Tower top lower part / Pivot tournant Pos. 1 zerlegt / Item 1 disassembled / Pos. 1 groupe mit Gelländer / with standard handrail / avec garde-corps		5,80	2,30	UV 20 2,42	6330	32,28
				5,80	2,30	TFS 20 2,42	5810	32,28
				5,80	2,30	UV 15 2,42	6260	32,28
2	1	Führerhausstation / Operator cabin station / Poste de cabine du grutier mit Führerhausabstiegs- und Schichtkasten / with cabin staircase and control cabinet / avec fixation cabine et armoire de distribution		4,78	2,00	2,55	2645	24,50
3	1	Gegenausleger / Counterjib / Contre-fleche mit Abwehrtellen, Gelländer und 1,7 t Gegengewicht / with stay parts, standard handrail and 1.7 t counterweight block / avec éléments de haubannage, garde-corps et 1,7 t blocs de contrepoids (ohne montiertes Handrail / without installed platform / sans grille-forme montée)		12,00	2,50	1,54	7250	46,50
					(2,30)			(42,50)
4	1	Hw 628.1 FU Hubwindenplattform / Hoisting gear platform / Plateforme de levage mit Hubzoll / with hoist rope / avec le câble de levage (170 m = 119 kg) ohne 2. Stresse / without 2nd bridle / sans 2ème brin		2,17	1,86	1,00	1800	4,04
5	1	Auslegerteil 1 / Jib part 1 / Élément de flèche 1		10,29	1,20	2,34	2770	28,89
6	1	Auslegerteil 2 / Jib part 2 / Élément de flèche 2		5,27	1,19	2,14	790	13,42
7	1	Auslegerteil 3 / Jib part 3 / Élément de flèche 3		10,27	1,19	2,09	1285	25,54
8	1	Auslegerteil 4 / Jib part 4 / Élément de flèche 4		5,26	1,18	1,65	615	10,24
9	1	Auslegerteil 5 / Jib part 5 / Élément de flèche 5		2,74	1,18	1,65	345	5,33
10	1	Auslegerteil 6 / Jib part 6 / Élément de flèche 6		10,24	1,18	1,65	990	20,25
11	1	Auslegerteil 7 / Jib part 7 / Élément de flèche 7		10,25	1,18	1,64	720	20,27
12	1	Auslegerteil 8 / Jib part 8 / Élément de flèche 8		10,24	1,18	1,65	585	19,94
13	1	SelbWirbeltraverse / Rope swivel traverse / Traverse de pointe fixe mit Gelländer / with standard handrail / avec garde-corps		0,98	1,19	1,46	140	1,70
14	1	Laufkatze LK 6 / Trolley LK 6 / Chariot de distribution LK 6		1,87	1,91	0,90	305	3,21
15	1	Wartungskorb LK 6 / Service cage LK 6 / Nacelle de transport de personne LK 6		0,75	0,58	1,69	55	0,74
16	1	Unterflasche U 6 / Hook block U 6 / Crochet U 6		0,40	0,34	0,87	225	0,12
17	10	Gegengewichtssteine / Counterweight blocks / Blocs de contrepoids		1,42	0,28	2,30	2050	1,16

Technische und inhaltliche Änderungen sind vorbehalten. / All rights reserved regarding technical and content changes. / Sous réserve de modifications techniques et de fond.

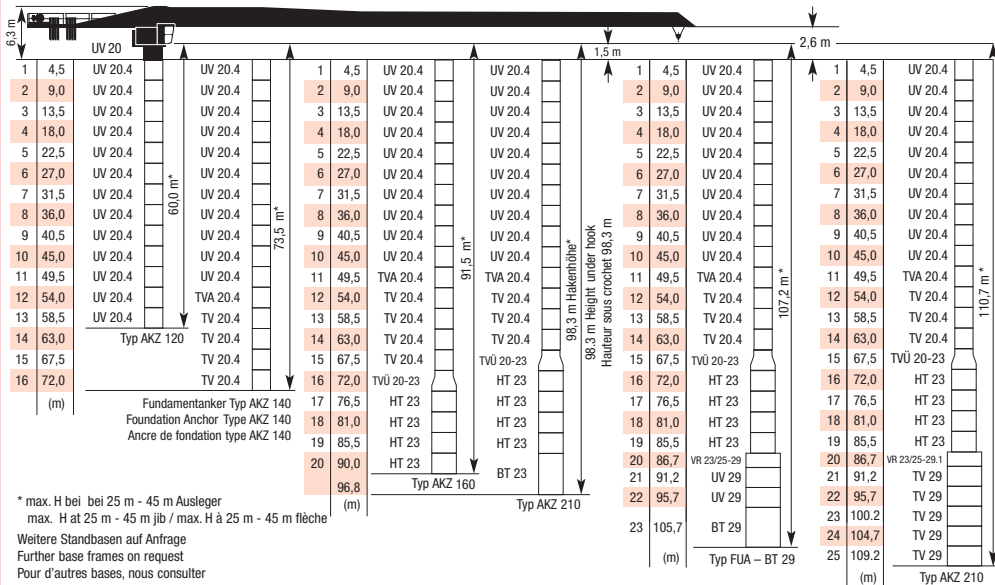
WOLFF 6020 Clear Turmkombinationen · Tower configurations · Combinaisons de tour

Traglasten [t] · WOLFF 6020.8 Clear

Load Data

Charges

Ausladung / jib radius / Portée [m]			20,0	22,5	25,0	27,5	30,0	32,5	35,0	37,5	40,0	42,5	45,0	47,5	50,0	52,5	55,0	57,5	60,0
Auslegerlänge / jib length / Longueur de flèche [m]	60,0	2,6 - 16,8	7,0	6,2	5,5	4,9	4,4	4,0	3,7	3,4	3,1	2,9	2,7	2,5	2,3	2,2	2,0	1,9	1,8
	57,5	2,6 - 17,4	7,3	6,4	5,7	5,1	4,6	4,2	3,8	3,5	3,2	3,0	2,8	2,6	2,4	2,3	2,1	2,0	
	55,0	2,6 - 17,8	7,5	6,6	5,8	5,2	4,7	4,3	3,9	3,6	3,3	3,1	2,9	2,7	2,5	2,3	2,2		
	52,5	2,6 - 18,1	7,6	6,7	5,9	5,3	4,8	4,4	4,0	3,7	3,4	3,2	2,9	2,7	2,6	2,4			
	50,0	2,6 - 19,4	8,2	7,2	6,4	5,8	5,2	4,7	4,4	4,0	3,7	3,4	3,2	3,0	2,8				
	47,5	2,6 - 19,4	8,2	7,2	6,4	5,8	5,2	4,8	4,4	4,0	3,7	3,5	3,2	3,0					
	45,0	2,6 - 19,9	8,4	7,4	6,6	5,9	5,4	4,9	4,5	4,1	3,8	3,5	3,3						
	42,5	2,6 - 20,1	8,5	7,5	6,7	6,0	5,4	5,0	4,6	4,2	3,9	3,6							
	40,0	2,6 - 20,2	8,5	7,6	6,7	6,0	5,5	5,0	4,6	4,2	3,9								
	37,5	2,6 - 20,2	8,5	7,5	6,7	6,0	5,5	5,0	4,6	4,2									
	35,0	2,6 - 20,0	8,5	7,5	6,6	6,0	5,4	4,9	4,5										
	32,5	2,6 - 19,9	8,5	7,4	6,6	5,9	5,4	4,9											
	30,0	2,6 - 20,0	8,5	7,5	6,6	6,0	5,4												
	27,5	2,6 - 20,1	8,5	7,5	6,7	6,0													
	25,0	2,6 - 20,2	8,5	7,5	6,7														







8,5 t

Tragfähigkeit / load capacity / Capacité de charge [t]























Antriebe · WOLFF 6020.8 Clear · (Hw 845 FU)

Mechanisms

Mécanismes

				
Motor [kW] motor Moteur	45	7,5	7,5	2 x 5,5
Geschwindigkeit speed Vitesse	0 - 1,6 t 0 ... 115 m/min stufenlos / stepless / en continue 0 - 8,5 t 0 ... 26 m/min	0 - 3,0 t 0 ... 100 m/min stufenlos / stepless / en continue 0 - 8,5 t 0 ... 65 m/min	0,80 min ⁻¹	25,0 m/min
Hakenweg [m] hook path course du crochet	190			

WOLFF 6020.8 Clear Kollif Liste - Colli List - Liste de colisage

Pos. Pos. Pos.	Stck. Pcs. Pcs.	Beschreibung / Description / Description	Kollif / Colli / Colis	L [m] Length Longueur	B [m] Width Largeur	H [m] Height Hauteur	Gewicht [kg] Weight Poids	Volumen [m³] Volume Volume
1	1	Turmspitze komplett / Tower top complete / Pointe de tour complète mit Abgabeln und Geländer / with stay parts and standard handrail / avec éléments de haubanage et garde-corps		6,30	2,30	2,42 UV 20	7290	35,07
				6,30	2,30	2,42 TFS 20	6770	35,07
				6,30	2,30	2,42 UV 15	7220	35,07
	1	Turmspitzenoberteil / Tower top upper part / Porte-flèche Pos. 1 zerlegt / Item 1 disassembled / Pos. 1 groupe mit Abgabeln / with stay parts / avec éléments de haubanage		2,19	0,66	1,84	960	2,66
				5,80	2,30	2,42 UV 20	6330	32,28
	1	Turmspitzenunterteil / Tower top lower part / Pivot tournant Pos. 1 zerlegt / Item 1 disassembled / Pos. 1 groupe mit Geländer / with standard handrail / avec garde-corps		5,80	2,30	2,42 TFS 20	5810	32,28
			5,80	2,30	2,42 UV 15	6260	32,28	
2	1	Führerhausstation / Operator cabin station / Poste de cabine du grutier mit Führerhausflügel und Schiebeteile / with cabin attachment and control cabinet / avec fixation cabine et armoire de distribution		4,78	2,00	2,55	2655	24,50
3	1	Gegenausleger / Counterjib / Contre-flèche mit Abgabeln, Geländer und 1,7 Gegengewicht / with stay parts, standard handrail and 1.7 counterweight block / avec éléments de haubanage, garde-corps et 1,7 blocs de contrepoids (ohne montierte Profile) / without mounted junctions / sans plate-forme montée		12,00	2,50	1,54	7250	46,50
4	1	Hw 845 FU Hubwindenplattform / Hoisting gear platform / Plateforme de levage mit Hubseil / with hoist rope / avec le câble de levage (170 m = 214 kg) ohne 2. Brenne / without 2nd brake / sans 2ème frein		2,17	1,57	1,04	2110	3,54
5	1	Auslegerteil 1 / Jib part 1 / Élément de flèche 1		10,29	1,20	2,34	2770	28,89
6	1	Auslegerteil 2 / Jib part 2 / Élément de flèche 2		5,27	1,19	2,14	790	13,42
7	1	Auslegerteil 3 / Jib part 3 / Élément de flèche 3		10,27	1,19	2,09	1285	25,54
8	1	Auslegerteil 4 / Jib part 4 / Élément de flèche 4		5,26	1,18	1,65	615	10,24
9	1	Auslegerteil 5 / Jib part 5 / Élément de flèche 5		2,74	1,18	1,65	345	5,33
10	1	Auslegerteil 6 / Jib part 6 / Élément de flèche 6		10,24	1,18	1,65	990	20,25
11	1	Auslegerteil 7 / Jib part 7 / Élément de flèche 7		10,25	1,18	1,64	720	20,27
12	1	Auslegerteil 8 / Jib part 8 / Élément de flèche 8		10,24	1,18	1,65	585	19,94
13	1	Seilwirbeltraverse / Rope swivel traverse / Traverse de pointe fixe mit Geländer / with standard handrail / avec garde-corps		0,98	1,19	1,46	140	1,70
14	1	Laufkatze LK 8 / Trolley LK 8 / Chariot de distribution LK 8		1,87	1,91	0,90	305	3,21
15	1	Wartungskorb LK 8 / Service cage LK 8 / Nacelle de transport de personne LK 8		0,75	0,58	1,69	55	0,74
16	1	Unterflasche U 8 / Hook block U 8 / Crochet U 8		0,52	0,19	1,11	345	0,11
17	10	Gegengewichtssteine / Counterweight blocks / Blocs de contrepoids		1,42	0,28	2,30	2050	1,16

Technische und inhaltliche Änderungen sind vorbehalten. / All rights reserved regarding technical and content changes. / Sous réserve de modifications techniques et de fond.

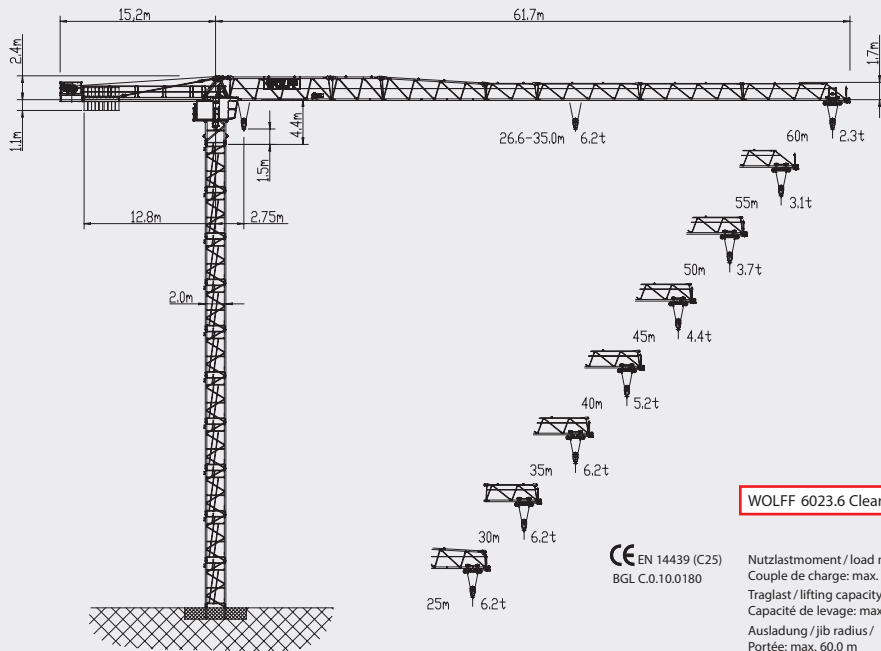

WOLFF 6023.6 Clear

CE EN 14439 (C25)
BGL C.0.10.0180

Nutzlastmoment / load moment /
Couple de charge: max. 2170 kNm
Traglast / lifting capacity /
Capacité de levage: max. 6,2 t
Ausladung / jib radius /
Portée: max. 60,0 m



WOLFF 6023 Clear Turmkombinationen - Tower configurations - Combinaisons de tour

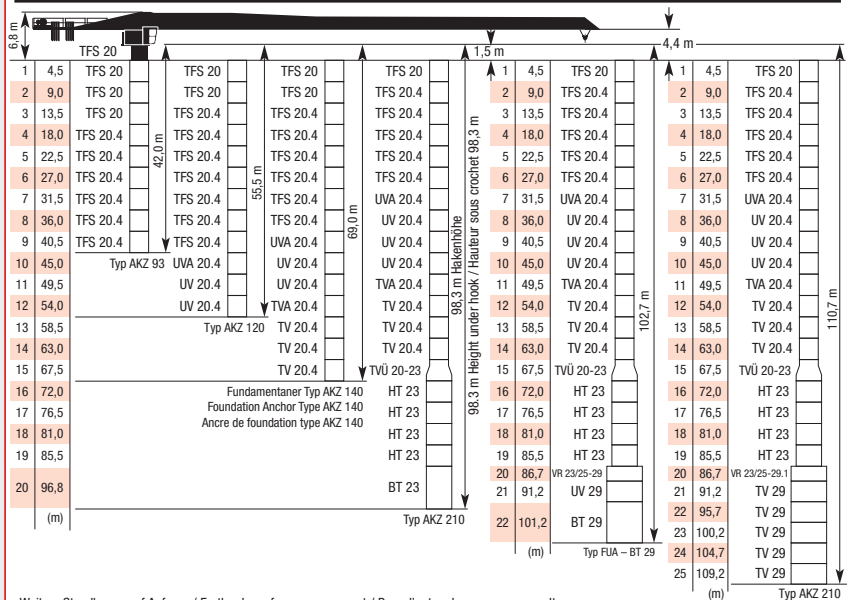

Weitere Standbasen auf Anfrage / Further base frames on request / Pour d'autres bases, nous consulter

WOLFF 6023 Clear Turmkombinationen - Tower configurations - Combinaisons de tour

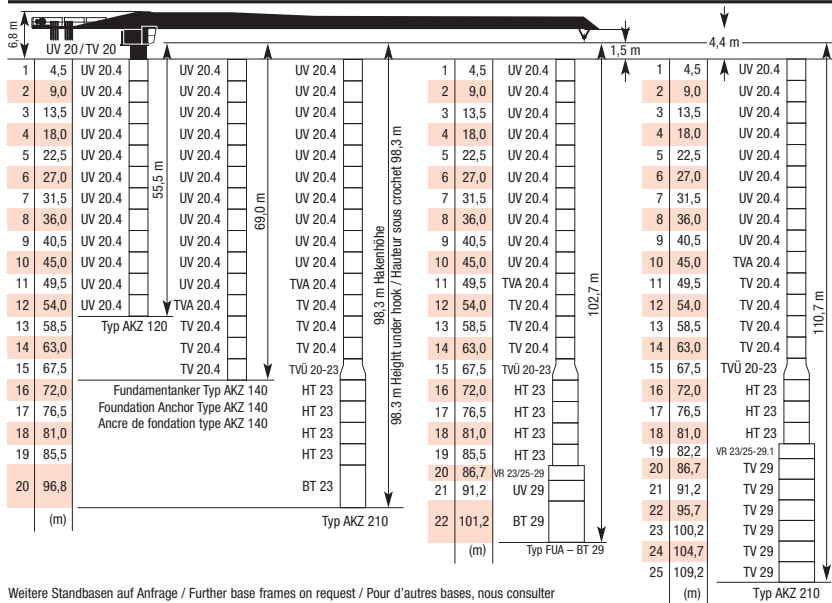

Weitere Standbasen auf Anfrage / Further base frames on request / Pour d'autres bases, nous consulter

Traglasten (t) • WOLFF 6023.6 Clear

Load Data

Charges

Ausladung (m) / jib radius (m) / Portée (m)		20	25	27,5	30	32,5	35	37,5	40	42,5	45	47,5	50	52,5	55	57,5	60		
Auslegerlänge (m) / jib length (m) / Longueur de flèche (m)	60,0	2,75 – 26,6	6,2	6,2	6,2	5,4	4,9	4,5	4,2	3,9	3,6	3,3	3,1	2,9	2,7	2,6	2,4	2,3	
	57,5	2,75 – 28,8	6,2	6,2	6,2	5,9	5,4	5,0	4,6	4,2	3,9	3,7	3,4	3,2	3,0	2,9	2,7		
	55,0	2,75 – 30,6	6,2	6,2	6,2	6,2	5,8	5,3	4,9	4,6	4,2	4,0	3,7	3,5	3,3	3,1			
	52,5	2,75 – 31,5	6,2	6,2	6,2	6,2	6,0	5,5	5,1	4,7	4,4	4,1	3,8	3,6	3,4				
	50,0	2,75 – 32,1	6,2	6,2	6,2	6,2	6,1	5,6	5,2	4,8	4,5	4,2	3,9	3,7					
	47,5	2,75 – 32,6	6,2	6,2	6,2	6,2	6,2	5,7	5,3	4,9	4,6	4,3	4,0						
	45,0	2,75 – 33,4	6,2	6,2	6,2	6,2	6,2	5,9	5,4	5,1	4,7	4,4							
	42,5	2,75 – 34,0	6,2	6,2	6,2	6,2	6,2	6,0	5,5	5,2	4,8								
	40,0	2,75 – 34,3	6,2	6,2	6,2	6,2	6,2	6,1	5,6	5,2									
	37,5	2,75 – 34,8	6,2	6,2	6,2	6,2	6,2	6,2	5,7										
	35,0	2,75 – 35,0	6,2	6,2	6,2	6,2	6,2	6,2											
	32,5	2,75 – 32,5	6,2	6,2	6,2	6,2	6,2												
	30,0	2,75 – 30,0	6,2	6,2	6,2	6,2													
	27,5	2,75 – 27,5	6,2	6,2	6,2														
	25,0	2,75 – 25,0	6,2	6,2															







Tragfähigkeit (t) / load capacity (t) / Capacité de charge (t)



















Antriebe · WOLFF 6023.6 Clear · (Hw 628 FU)

Mechanisms

Mécanismes

				
Motor (kW) motor Moteur	28	7,5	7,5	2 x 5,5
Geschwindigkeit speed Vitesse	0 – 2,5 t 0...52 m/min stufenlos/ stepless/ en continue 0 – 6,2 t 0...23 m/min	0 – 3,0 t 0...100 m/min stufenlos/ stepless/ en continue 0 – 6,2 t 0...78 m/min	0,80 min ⁻¹	25,0 m/min
Hakenweg (m) hook path course du crochet	190			

WOLFF 6023.6 Clear Kolli Liste - Colli List - Liste de colisage

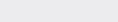
Pos. Pos. Pos.	Stck. Pce. Pcs.	Beschreibung / Description / Description	Kolli / Colli / Coils	L (m) Length Longueur	B (m) Width Largeur	H (m) Height Hauteur	Gewicht (kg) Weight Poids	Volumen (m³) Volume Volume
1	1	Turmspitze kompl. / Tower top complete / Pointe de tour complète		6,67	2,30	UV 20 / TV 20 2,54 TFS 20	9065	38,97
				6,67	2,30	2,54	8325	38,97
		Turmspitzenoberteil / Tower top upper part / Porte-flèche <small>Pos. 1 zerlegt / Item 1 disassembled / Pos. 1 groupe</small>		2,33	0,58	2,81	1300	3,80
		Turmspitzenunterteil / Tower top lower part / Pivot tournant <small>Pos. 1 zerlegt / Item 1 disassembled / Pos. 1 groupe</small>		5,97	2,30	UV 20 / TV 20 2,54 TFS 20	7765	34,88
			5,97	2,30	2,54	7025	34,88	
2	1	Führerhaus mit Aufhängung / Driver's cabin with suspension / Cabine avec fixation		4,82	1,96	2,55	2580	24,10
3	1	Gegenausleger komplett / Counterjib complete / Contre-flèche complète		14,04	2,30	0,80	6840	25,84
4	1	Hw 628 FU Hubwindenplattform / Hoisting platform / Plateforme de levage sans armoir électrique		2,17	1,57	1,04	1760	3,54
5	1	Kiste (Kleinteile) / Box (small part's) / Caisse à outils		0,63	0,50	0,38	100	1,12
6	1	Auslegerteil 1 / Jib part 1 / Élément de flèche 1		10,32	1,20	2,55	2952	31,64
7	1	Auslegerteil 2 / Jib part 2 / Élément de flèche 2		5,31	1,20	2,38	1033	15,17
8	1	Auslegerteil 3 / Jib part 3 / Élément de flèche 3		10,29	1,20	2,34	1600	28,90
9	1	Auslegerteil 4 / Jib part 4 / Élément de flèche 4		5,27	1,20	1,74	775	11,00
10	1	Auslegerteil 5 / Jib part 5 / Élément de flèche 5		2,77	1,20	1,74	470	5,78
11	1	Auslegerteil 6 / Jib part 6 / Élément de flèche 6		10,25	1,20	1,72	1365	21,16
12	1	Auslegerteil 7 / Jib part 7 / Élément de flèche 7		10,17	1,20	1,70	1045	20,75
13	1	Auslegerteil 8 / Jib part 8 / Élément de flèche 8		10,17	1,20	1,70	800	20,75
14	1	Seilwirbeltraverse / Rope swivel traverse / Traverse de pointe fixe		0,99	1,09	0,45	126	0,49
15	1	Laufkatze LK 8 / Trolley LK 8 / Chariot de distribution LK 8		1,87	1,36	0,95	290	2,42
16	1	Wartungskorb LK 8 / Service cage LK 8 / Nacelle de transport de personne LK 8		0,75	0,55	1,69	55	0,70
17	1	Unterflasche U 6 (8) / Hook block U 6 (8) / Crochet U 6 (8)		0,50	0,22	1,11	350	0,12

Technische und inhaltliche Änderungen sind vorbehalten. / All rights reserved regarding technical and content changes. / Sous réserve de modifications techniques et de fond.

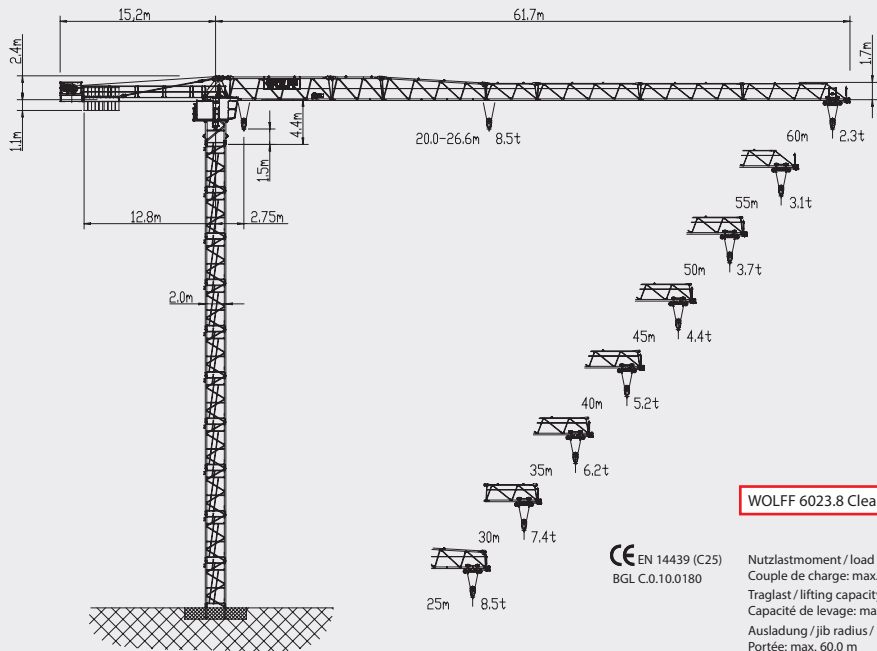

WOLFF 6023.8 Clear

CE EN 14439 (C25)
BGL C.0.10.0180

Nutzlastmoment / load moment /
Couple de charge: max. 2260 kNm
Traglast / lifting capacity /
Capacité de levage: max. 8,5 t
Ausladung / jib radius /
Portée: max. 60,0 m



WOLFF 6023 Clear Turmkombinationen - Tower configurations - Combinaisons de tour

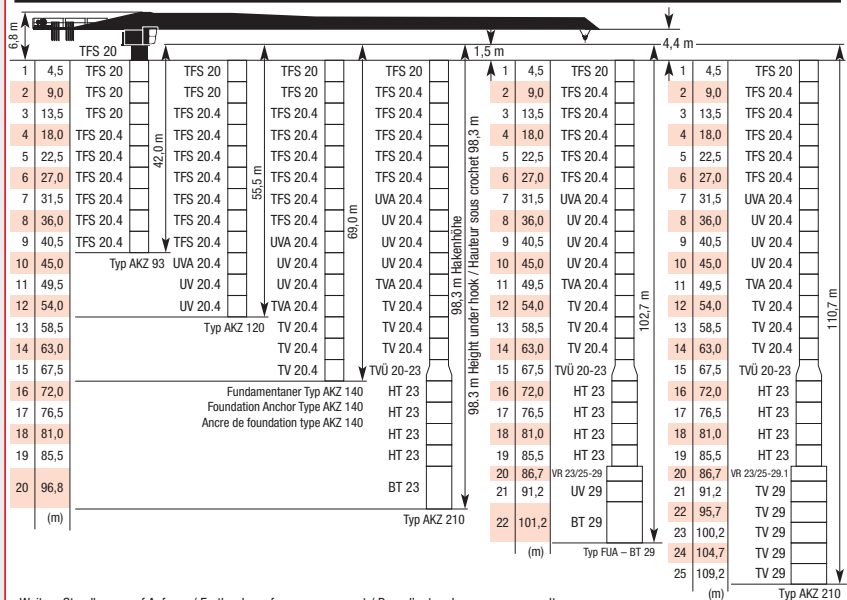

Weitere Standbasen auf Anfrage / Further base frames on request / Pour d'autres bases, nous consulter

WOLFF 6023 Clear Turmkombinationen - Tower configurations - Combinaisons de tour

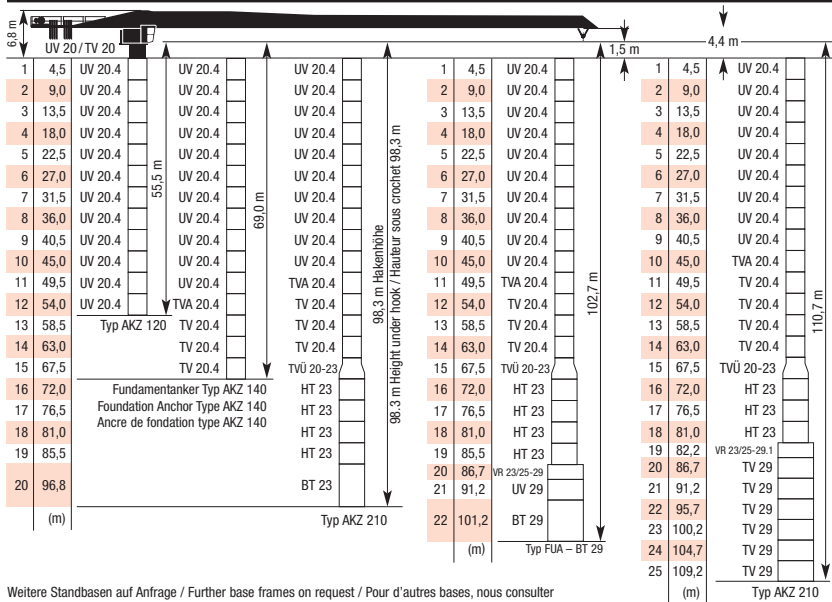

Weitere Standbasen auf Anfrage / Further base frames on request / Pour d'autres bases, nous consulter

Traglasten (t) • WOLFF 6023.8 Clear

Load Data

Charges

Ausladung (m) / jib radius (m) / Portée (m)		20	25	27,5	30	32,5	35	37,5	40	42,5	45	47,5	50	52,5	55	57,5	60	
Auslegerlänge (m) / jib length (m) / Longueur de flèche (m)	60,0	2,75 – 20,0	8,5	6,6	6,0	5,4	4,9	4,5	4,2	3,9	3,6	3,3	3,1	2,9	2,7	2,6	2,4	2,3
	57,5	2,75 – 21,6	8,5	7,3	6,5	5,9	5,4	5,0	4,6	4,2	3,9	3,7	3,4	3,2	3,0	2,9	2,7	
	55,0	2,75 – 23,1	8,5	7,8	7,0	6,4	5,8	5,3	4,9	4,6	4,2	4,0	3,7	3,5	3,3	3,1		
	52,5	2,75 – 23,7	8,5	8,0	7,2	6,6	6,0	5,5	5,1	4,7	4,4	4,1	3,8	3,6	3,4			
	50,0	2,75 – 24,2	8,5	8,2	7,4	6,7	6,1	5,6	5,2	4,8	4,5	4,2	3,9	3,7				
	47,5	2,75 – 24,5	8,5	8,5	7,5	6,8	6,2	5,7	5,3	4,9	4,6	4,3	4,0					
	45,0	2,75 – 25,2	8,5	8,5	7,7	7,0	6,4	5,9	5,4	5,1	4,7	4,4						
	42,5	2,75 – 25,6	8,5	8,5	7,9	7,1	6,5	6,0	5,5	5,2	4,8							
	40,0	2,75 – 25,8	8,5	8,5	7,9	7,2	6,6	6,1	5,6	5,2								
	37,5	2,75 – 26,2	8,5	8,5	8,1	7,3	6,7	6,2	5,7									
	35,0	2,75 – 26,3	8,5	8,5	8,1	7,4	6,7	6,2										
	32,5	2,75 – 26,6	8,5	8,5	8,2	7,4	6,8											
	30,0	2,75 – 26,5	8,5	8,5	8,2	7,4												
	27,5	2,75 – 26,3	8,5	8,5	8,1													
	25,0	2,75 – 25,0	8,5	8,5														







8,5 t

Tragfähigkeit (t) / load capacity (t) / Capacité de charge (t)

Antriebe · WOLFF 6023.8 Clear · (Hw 845 FU)

Mechanisms





Mécanismes

				
Motor (kW) motor Moteur	45	7,5	7,5	2 x 5,5
Geschwindigkeit speed Vitesse	0 – 1,6 t 0...115 m/min stufenlos/ stepless/ en continue 0 – 8,5 t 0...26 m/min	0 – 3,0 t 0...100 m/min stufenlos/ stepless/ en continue 0 – 8,5 t 0...65 m/min	0,80 min ⁻¹	25,0 m/min
Hakenweg (m) hook path course du crochet	190			

Antriebe · WOLFF 6023.8 Clear · (Hw 875 FU)

Mechanisms

Mécanismes

				
Motor (kW) motor Moteur	75	7,5	7,5	2 x 5,5
Geschwindigkeit speed Vitesse	0 – 1,7 t 0...170 m/min stufenlos/ stepless/ en continue 0 – 8,5 t 0...42 m/min	0 – 3,0 t 0...100 m/min stufenlos/ stepless/ en continue 0 – 8,5 t 0...65 m/min	0,80 min ⁻¹	25,0 m/min
Hakenweg (m) hook path course du crochet	460			

WOLFF 6023.8 Clear Kolli Liste - Colli List - Liste de colisage

Pos. Pos. Pos.	Stck. Poe. Pcs.	Beschreibung / Description / Description	Kolli / Colli / Colis	L (m) Length Longueur	B (m) Width Largeur	H (m) Height Hauteur	Gewicht (kg) Weight Poids	Volumen (m³) Volume Volume
1	1	Turmspitze kompl. / Tower top complete / Pointe de tour complète		6,67	2,30	2,54	9065	38,97
				6,67	2,30	2,54	8325	38,97
				2,33	0,58	2,81	1300	3,80
				5,97	2,30	2,54	7765	34,88
				5,97	2,30	2,54	7025	34,88
		Turmspitzenoberteil / Tower top upper part / Porte-flèche Pos. 1 zerlegt / Item 1 disassembled / Pos. 1 groupe						
		Turmspitzenunterteil / Tower top lower part / Pivot tournant Pos. 1 zerlegt / Item 1 disassembled / Pos. 1 groupe						
2	1	Führerhaus mit Aufhängung / Driver's cabin with suspension / Cabine avec fixation		4,82	1,96	2,55	2580	24,10
3	1	Gegenausleger komplett / Counterjib complete / Contre-flèche complète		14,04	2,30	0,80	6840	25,84
4	1	Hw 845 FU Hubwindenplattform / Hoisting platform / Plateforme de levage sans armoire électrique Hw 875 FU Hubwindenplattform / Hoisting platform / Plateforme de levage sans armoire électrique		2,17	1,57	1,04	2035	3,54
				2,17	1,88	1,18	2375	4,82
5	1	Kiste (Kleinteile) / Box (small part's) / Caisse à outils	 Hw 845 FU Hw 875 FU	0,63	0,50	0,38	100	1,12
6	1	Auslegerteil 1 / Jib part 1 / Élément de flèche 1		10,32	1,20	2,55	2952	31,64
7	1	Auslegerteil 2 / Jib part 2 / Élément de flèche 2		5,31	1,20	2,38	1033	15,17
8	1	Auslegerteil 3 / Jib part 3 / Élément de flèche 3		10,29	1,20	2,34	1600	28,90
9	1	Auslegerteil 4 / Jib part 4 / Élément de flèche 4		5,27	1,20	1,74	775	11,00
10	1	Auslegerteil 5 / Jib part 5 / Élément de flèche 5		2,77	1,20	1,74	470	5,78
11	1	Auslegerteil 6 / Jib part 6 / Élément de flèche 6		10,25	1,20	1,72	1365	21,16
12	1	Auslegerteil 7 / Jib part 7 / Élément de flèche 7		10,17	1,20	1,70	1045	20,75
13	1	Auslegerteil 8 / Jib part 8 / Élément de flèche 8		10,17	1,20	1,70	800	20,75
14	1	Seilwirbeltraverse / Rope swivel traverse / Traverse de pointe fixe		0,99	1,09	0,45	126	0,49
15	1	Laufkatze LK 8 / Trolley LK 8 / Chariot de distribution LK 8		1,87	1,36	0,95	290	2,42
16	1	Wartungskorb LK 8 / Service cage LK 8 / Nacelle de transport de personne LK 8		0,75	0,55	1,69	55	0,70
17	1	Unterflasche U 6 (8) / Hook block U 6 (8) / Crochet U 6 (8)		0,50	0,22	1,11	350	0,12

Technische und inhaltliche Änderungen sind vorbehalten. / All rights reserved regarding technical and content changes. / Sous réserve de modifications techniques et de fond.

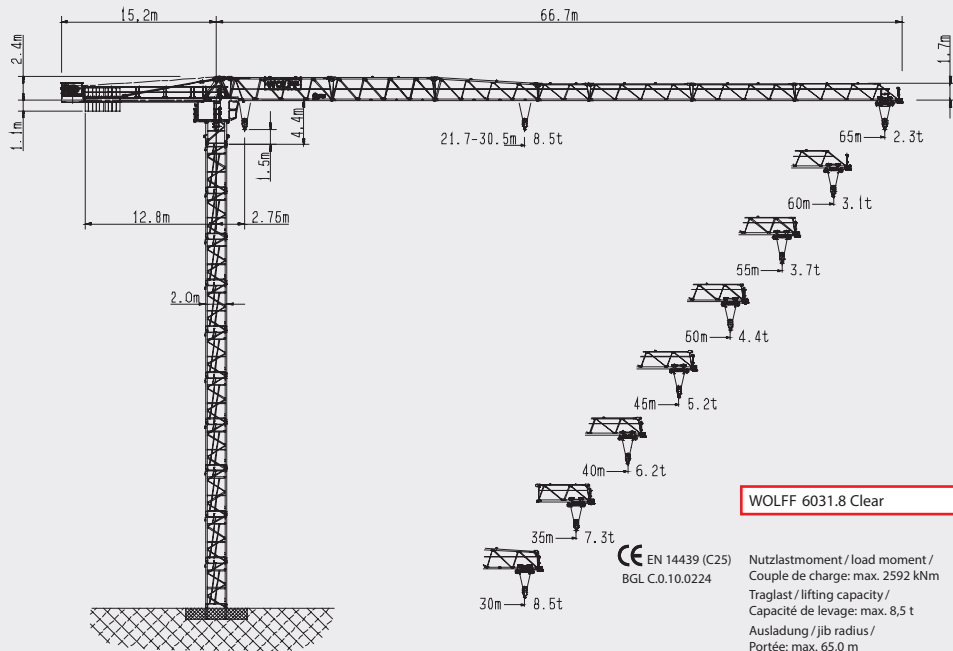

WOLFF 6031.8 Clear Turmkombinationen · Tower configurations · Combinaisons de tour

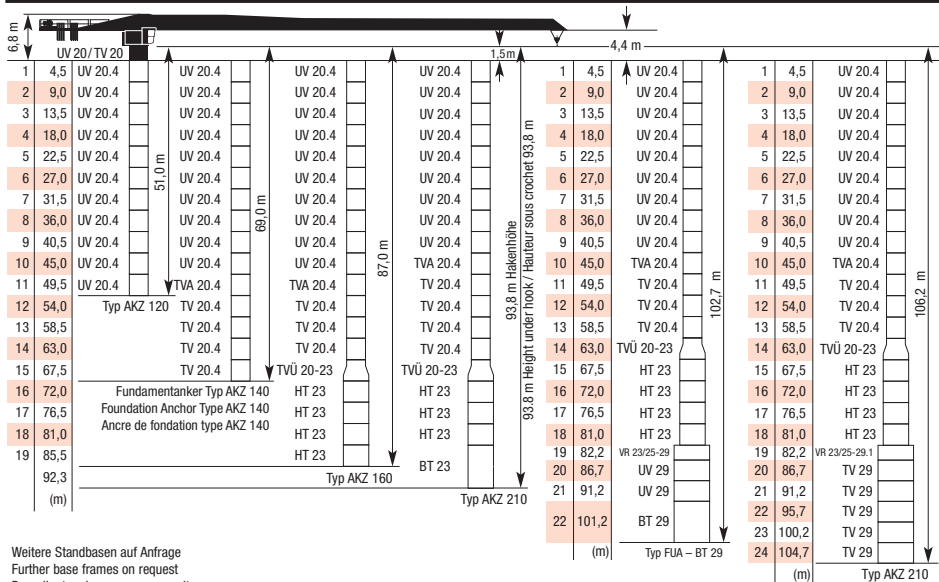

Traglasten (t) · WOLFF 6031.8 Clear

Load Data

Charges



Ausladung (m) / jib radius (m) / Portée (m)		25	30	32,5	35	37,5	40	42,5	45	47,5	50	52,5	55	57,5	60	62,5	65		
Auslegerlänge (m) / jib length (m) / Longueur de flèche (m)	65,0	2,75 – 21,7	7,3	5,9	5,4	5,0	4,6	4,2	3,9	3,7	3,4	3,2	3,0	2,9	2,7	2,6	2,4	2,3	Tragfähigkeit (t) / load capacity (t) / Capacité de charge (t)
	62,5	2,75 – 23,5	8,0	6,5	5,9	5,5	5,0	4,7	4,3	4,1	3,8	3,6	3,4	3,2	3,0	2,8	2,7		
	60,0	2,75 – 25,2	8,5	7,0	6,4	5,9	5,4	5,1	4,7	4,4	4,1	3,9	3,7	3,5	3,3	3,1			
	57,5	2,75 – 26,0	8,5	7,3	6,6	6,1	5,6	5,2	4,9	4,6	4,3	4,0	3,8	3,6	3,4				
	55,0	2,75 – 26,6	8,5	7,5	6,8	6,3	5,8	5,4	5,0	4,7	4,4	4,2	3,9	3,7					
	52,5	2,75 – 27,1	8,5	7,6	7,0	6,4	5,9	5,5	5,1	4,8	4,5	4,2	4,0						
	50,0	2,75 – 28,0	8,5	7,9	7,2	6,6	6,1	5,7	5,3	5,0	4,7	4,4							
	47,5	2,75 – 28,6	8,5	8,1	7,4	6,8	6,3	5,9	5,5	5,1	4,8								
	45,0	2,75 – 29,0	8,5	8,2	7,5	6,9	6,4	6,0	5,6	5,2									
	42,5	2,75 – 29,7	8,5	8,4	7,7	7,1	6,6	6,1	5,7										
	40,0	2,75 – 30,1	8,5	8,5	7,8	7,2	6,7	6,2											
	37,5	2,75 – 30,2	8,5	8,5	7,9	7,2	6,7												
	35,0	2,75 – 30,5	8,5	8,5	7,9	7,3													
	32,5	2,75 – 30,4	8,5	8,5	7,9														
	30,0	2,75 – 30,0	8,5	8,5															



Antriebe · WOLFF 6031.8 Clear · (Hw 845 FU)

Mechanisms

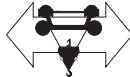



Mécanismes

				
Motor (kW) motor Moteur	45	7,5	2 x 6,0	2 x 5,5
Geschwindigkeit speed Vitesse	0 – 1,6 t 0...115 m/min stufenlos/ stepless/ en continue 0 – 8,5 t 0...26 m/min	0 – 3,0 t 0...100 m/min stufenlos/ stepless/ en continue 0 – 8,5 t 0...65 m/min	0,80 min ⁻¹	25,0 m/min
Hakenweg (m) hook path course du crochet	190			





















Antriebe · WOLFF 6031.8 Clear · (Hw 875 FU)

Mechanisms

Mécanismes

				
Motor (kW) motor Moteur	75	7,5	2 x 6,0	2 x 5,5
Geschwindigkeit speed Vitesse	0 – 1,7 t 0...170 m/min stufenlos/ stepless/ en continue 0 – 8,5 t 0...42 m/min	0 – 3,0 t 0...100 m/min stufenlos/ stepless/ en continue 0 – 8,5 t 0...65 m/min	0,80 min ⁻¹	25,0 m/min
Hakenweg (m) hook path course du crochet	460			

WOLFF 6031.8 Clear Kollifliste - Colli List - Liste de colisage

Pos. Pos. Pos.	Stck. Pce. Pcs.	Beschreibung / Description / Description	Kollif / Colli / Coils	L (m) Length Longueur	B (m) Width Largeur	H (m) Height Hauteur	Gewicht (kg) Weight Poids	Volumen (m³) Volume Volume
1	1	Turmspitze kompl. / Tower top complete / Pointe de tour complète		6,67	2,30	2,54	9370	38,97
		Turmspitzenoberteil / Tower top upper part / Porte-flèche Pos. 1 zerlegt / Item 1 disassembled / Pos. 1 groupe		2,33	0,58	2,81	1300	3,80
		Turmspitzenunterteil / Tower top lower part / Pivot tournant Pos. 1 zerlegt / Item 1 disassembled / Pos. 1 groupe		5,77	2,30	2,54	8070	33,71
2	1	Führerhaus mit Aufhängung / Driver's cabin with suspension / Cabine avec fixation		4,82	1,96	2,55	2580	24,10
3	1	Gegenausleger komplett / Counterjib complete / Contre-flèche complète		14,04	2,30	0,80	6840	25,84
4	1	Hw 845 FU Hubwindenplattform / Hoisting platform / Plateforme de levage sans armoire électrique		2,17	1,57	1,04	2035	3,54
		Hw 875 FU Hubwindenplattform / Hoisting platform / Plateforme de levage sans armoire électrique		2,17	1,88	1,18	2375	4,82
5	1	Kiste (Kleinteile) / Box (small part's) / Caisse à outils		0,63	0,50	0,38	100	1,12
6	1	Auslegerteil 1 / Jib part 1 / Élément de flèche 1		10,34	1,20	2,55	3265	31,64
7	1	Auslegerteil 2 / Jib part 2 / Élément de flèche 2		10,32	1,20	2,36	2150	29,23
8	1	Auslegerteil 3 / Jib part 3 / Élément de flèche 3		10,29	1,20	2,34	1600	28,90
9	1	Auslegerteil 4 / Jib part 4 / Élément de flèche 4		5,27	1,20	1,74	775	11,00
10	1	Auslegerteil 5 / Jib part 5 / Élément de flèche 5		2,77	1,20	1,74	470	5,78
11	1	Auslegerteil 6 / Jib part 6 / Élément de flèche 6		10,25	1,20	1,72	1365	21,16
12	1	Auslegerteil 7 / Jib part 7 / Élément de flèche 7		10,17	1,20	1,70	1045	20,75
13	1	Auslegerteil 8 / Jib part 8 / Élément de flèche 8		10,17	1,20	1,70	800	20,75
14	1	Seilwirbeltraverse / Rope swivel traverse / Traverse de pointe fixe		0,99	1,09	0,45	126	0,49
15	1	Laufkatze LK 8 / Trolley LK 8 / Chariot de distribution LK 8		1,87	1,36	0,95	290	2,42
16	1	Wartungskorb LK 8 / Service cage LK 8 / Nacelle de transport de personne LK 8		0,75	0,55	1,69	55	0,70
17	1	Unterflasche U 6 (B) / Hook block U 6 (B) / Crochet U 6 (B)		0,50	0,22	1,11	350	0,12

Technische und inhaltliche Änderungen sind vorbehalten. / All rights reserved regarding technical and content changes. / Sous réserve de modifications techniques et de fond.

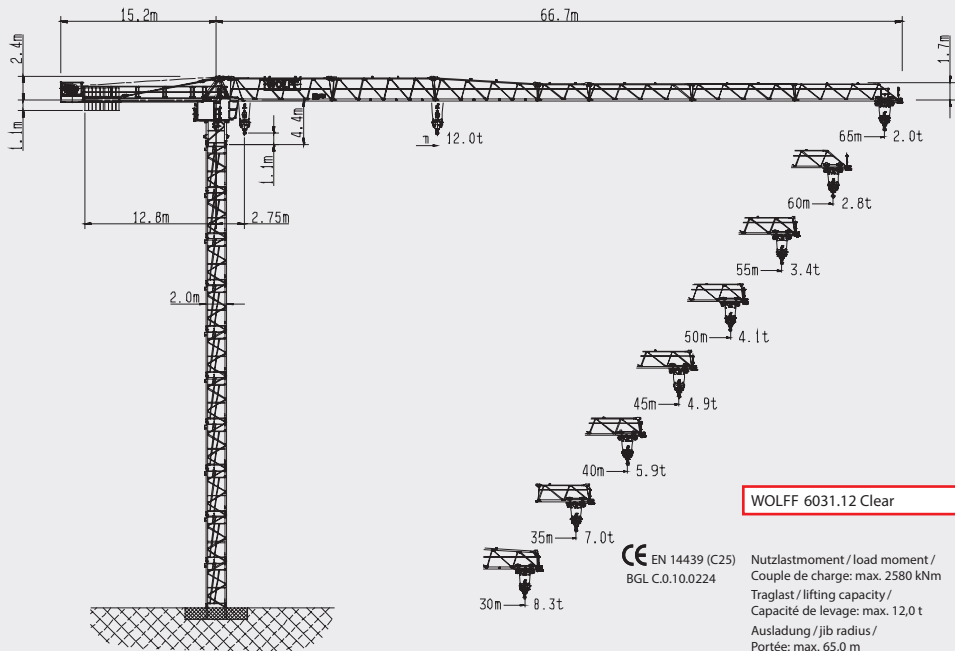

WOLFF 6031.12 Clear Turmkombinationen - Tower configurations - Combinaisons de tour

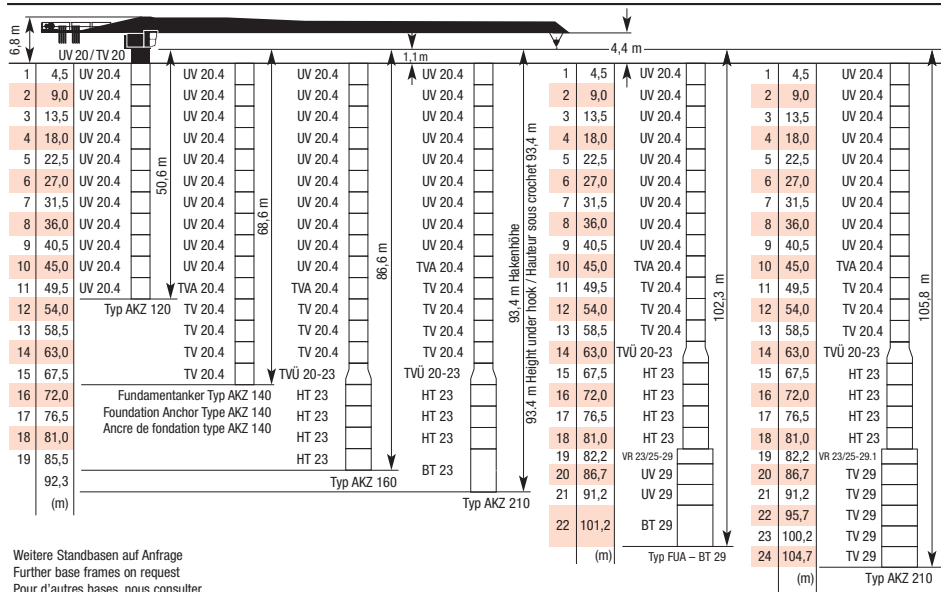

Weitere Standbasen auf Anfrage
Further base frames on request
Pour d'autres bases, nous consulter

Traglasten (t) · WOLFF 6031.12 Clear

Load Data

Charges

Ausladung (m) / jib radius (m) / Portée (m)			25	30	32,5	35	37,5	40	42,5	45	47,5	50	52,5	55	57,5	60	62,5	65	
Auslegerlänge (m) / jib length (m) / Longueur de flèche (m)	65,0	2,75 – 21,4	7,0	5,6	5,1	4,7	4,3	3,9	3,6	3,4	3,1	2,9	2,7	2,6	2,4	2,3	2,1	2,0	
	62,5	2,75 – 23,3	7,7	6,2	5,6	5,2	4,7	4,4	4,0	3,8	3,5	3,3	3,1	2,9	2,7	2,5	2,4		
	60,0	2,75 – 24,9	8,3	6,7	6,1	5,6	5,1	4,8	4,4	4,1	3,8	3,6	3,4	3,2	3,0	2,8			
	57,5	2,75 – 25,7	8,3	7,0	6,3	5,8	5,3	4,9	4,6	4,3	4,0	3,7	3,5	3,3	3,1				
	55,0	2,75 – 26,3	8,3	7,2	6,5	6,0	5,5	5,1	4,7	4,4	4,1	3,9	3,6	3,4					
	52,5	2,75 – 26,8	8,3	7,3	6,7	6,1	5,6	5,2	4,8	4,5	4,2	3,9	3,7						
	50,0	2,75 – 27,7	8,3	7,6	6,9	6,3	5,8	5,4	5,0	4,7	4,4	4,1							
	47,5	2,75 – 28,3	8,3	7,8	7,1	6,5	6,0	5,6	5,2	4,8	4,5								
	45,0	2,75 – 28,7	8,3	7,9	7,2	6,6	6,1	5,7	5,3	4,9									
	42,5	2,75 – 29,4	8,3	8,1	7,4	6,8	6,3	5,8	5,4										
	40,0	2,75 – 29,8	8,3	8,2	7,5	6,9	6,4	5,9											
	37,5	2,75 – 29,9	8,3	8,3	7,6	6,9	6,4												
	35,0	2,75 – 30,2	8,3	8,3	7,6	7,0													
	32,5	2,75 – 30,1	8,3	8,3	7,6														
	30,0	2,75 – 30,0	8,3	8,3															



8,3 t

Tragfähigkeit (t) / load capacity (t) / Capacité de charge (t)

Traglasten (t) · WOLFF 6031.12 Clear

Load Data

Charges

Ausladung (m) / jib radius (m) / Portée (m)		25	30	32,5	35	37,5	40	42,5	45	47,5	50	52,5	55	57,5	60	62,5	65		
Auslegerlänge (m) / jib length (m) / Longueur de flèche (m)	65,0	2,75 – 15,3	6,9	5,5	5,0	4,6	4,2	3,8	3,5	3,3	3,0	2,8	2,6	2,5	2,3	2,2	2,0	1,9	Tragfähigkeit (t) / load capacity (t) / Capacité de charge (t)
	62,5	2,75 – 16,6	7,6	6,1	5,5	5,1	4,6	4,3	3,9	3,7	3,4	3,2	3,0	2,8	2,6	2,4	2,3		
	60,0	2,75 – 17,7	8,2	6,6	6,0	5,5	5,0	4,7	4,3	4,0	3,7	3,5	3,3	3,1	2,9	2,7			
	57,5	2,75 – 18,3	8,5	6,9	6,2	5,7	5,2	4,8	4,5	4,2	3,9	3,6	3,4	3,2	3,0				
	55,0	2,75 – 18,8	8,7	7,1	6,4	5,9	5,4	5,0	4,6	4,3	4,0	3,8	3,5	3,3					
	52,5	2,75 – 19,1	8,9	7,2	6,6	6,0	5,5	5,1	4,7	4,4	4,1	3,8	3,6						
	50,0	2,75 – 19,7	9,2	7,5	6,8	6,2	5,7	5,3	4,9	4,6	4,3	4,0							
	47,5	2,75 – 20,2	9,4	7,7	7,0	6,4	5,9	5,5	5,1	4,7	4,4								
	45,0	2,75 – 20,5	9,6	7,8	7,1	6,5	6,0	5,6	5,2	4,8									
	42,5	2,75 – 20,9	9,9	8,0	7,3	6,7	6,2	5,7	5,3										
	40,0	2,75 – 21,2	10,0	8,1	7,4	6,8	6,3	5,8											
	37,5	2,75 – 21,3	10,1	8,2	7,5	6,8	6,3												
	35,0	2,75 – 21,5	10,1	8,2	7,5	6,9													
	32,5	2,75 – 21,4	10,1	8,2	7,5														
	30,0	2,75 – 21,4	10,1	8,2															







12,0 t

Antriebe · WOLFF 6031.12 Clear · (Hw 845 FU)

Mechanisms





Mécanismes

					
Motor (kW) motor Moteur	45	45	7,5	2 x 6,0	2 x 5,5
Geschwindigkeit speed Vitesse	0 – 1,3 t 0...115 m/min stufenlos/ stepless/ en continue 0 – 8,3 t 0...26 m/min	0 – 3,5 t 0...58 m/min stufenlos/ stepless/ en continue 0 – 12,0 t 0...18 m/min	0 – 3,0 t 0...100 m/min stufenlos/ stepless/ en continue 0 – 8,3 t 0...65 m/min 0 – 12,0 t 0...40 m/min	0,8 min ⁻¹	25,0 m/min
Hakenweg (m) hook path course du crochet	190	95			



















Antriebe · WOLFF 6031.12 Clear · (Hw 875 FU)

Mechanisms

Mécanismes

					
Motor (kW) motor Moteur	75	75	7,5	2 x 6,0	2 x 5,5
Geschwindigkeit speed Vitesse	0 – 1,5 t 0...170 m/min stufenlos/ stepless/ en continue 0 – 8,3 t 0...42 m/min	0 – 3,7 t 0...85 m/min stufenlos/ stepless/ en continue 0 – 12,0 t 0...29 m/min	0 – 3,0 t 0...100 m/min stufenlos/ stepless/ en continue 0 – 8,3 t 0...65 m/min 0 – 12,0 t 0...40 m/min	0,8 min ⁻¹	25,0 m/min
Hakenweg (m) hook path course du crochet	460	230			

WOLFF 6031.12 Clear Kolli Liste - Colli List - Liste de colisage

Pos. Pos. Pos.	Stck. Pce. Pcs.	Beschreibung / Description / Description	Kolli / Colli / Colis	L (m) Length Longueur	B (m) Width Largeur	H (m) Height Hauteur	Gewicht (kg) Weight Poids	Volumen (m³) Volume Volume
1	1	Turmspitze kompl. / Tower top complete / Pointe de tour complète Turmspitzenoberteil / Tower top upper part / Porte-flèche Pos. 1 zerlegt / Item 1 disassembled / Pos. 1 groupe Turmspitzenunterteil / Tower top lower part / Pivot tournant Pos. 1 zerlegt / Item 1 disassembled / Pos. 1 groupe		6,67 2,33	2,30 0,58	2,54 2,81	9370 1300	38,97 3,80
2	1	Führerhaus mit Aufhängung / Driver's cabin with suspension / Cabine avec fixation		4,82	1,96	2,55	2580	24,10
3	1	Gegenausleger komplett / Counterjib complete / Contre-flèche complète		14,04	2,30	0,80	6840	25,84
4	1	Hw 845 FU Hubwindenplattform / Hoisting platform / Plateforme de levage sans armoire électrique Hw 875 FU Hubwindenplattform / Hoisting platform / Plateforme de levage sans armoire électrique		2,17 2,17	1,57 1,88	1,04 1,18	2035 2375	3,54 4,82
5	1	Kiste (Kleinteile) / Box (small part's) / Caisse à outils	Hw 845 FU  Hw 875 FU 	0,63	0,50	0,38	100	1,12
6	1	Auslegerteil 1 / Jib part 1 / Élément de flèche 1		10,34	1,20	2,55	3265	31,64
7	1	Auslegerteil 2 / Jib part 2 / Élément de flèche 2		10,32	1,20	2,36	2150	29,23
8	1	Auslegerteil 3 / Jib part 3 / Élément de flèche 3		10,29	1,20	2,34	1600	28,90
9	1	Auslegerteil 4 / Jib part 4 / Élément de flèche 4		5,27	1,20	1,74	775	11,00
10	1	Auslegerteil 5 / Jib part 5 / Élément de flèche 5		2,77	1,20	1,74	470	5,78
11	1	Auslegerteil 6 / Jib part 6 / Élément de flèche 6		10,25	1,20	1,72	1365	21,16
12	1	Auslegerteil 7 / Jib part 7 / Élément de flèche 7		10,17	1,20	1,70	1045	20,75
13	1	Auslegerteil 8 / Jib part 8 / Élément de flèche 8		10,17	1,20	1,70	800	20,75
14	1	Seilwirbeltraverse / Rope swivel traverse / Traverse de pointe fixe		0,99	1,09	0,45	126	0,49
15	1	Laufkatze LK 8/12 / Trolley LK 8/12 / Chariot de distribution LK 8/12		1,87	1,38	1,03	355	2,66
16	1	Wartungskorb LK 8/12 / Service cage LK 8/12 / Nacelle de transport de personne LK 8/12		0,75	0,55	1,69	55	0,70
17	1	Unterflasche U 8/16 AU / Hook block U 8/16 AU / Crochet U 8/16 AU		1,02	0,27	1,84	550	0,51

Technische und inhaltliche Änderungen sind vorbehalten. / All rights reserved regarding technical and content changes. / Sous réserve de modifications techniques et de fond.

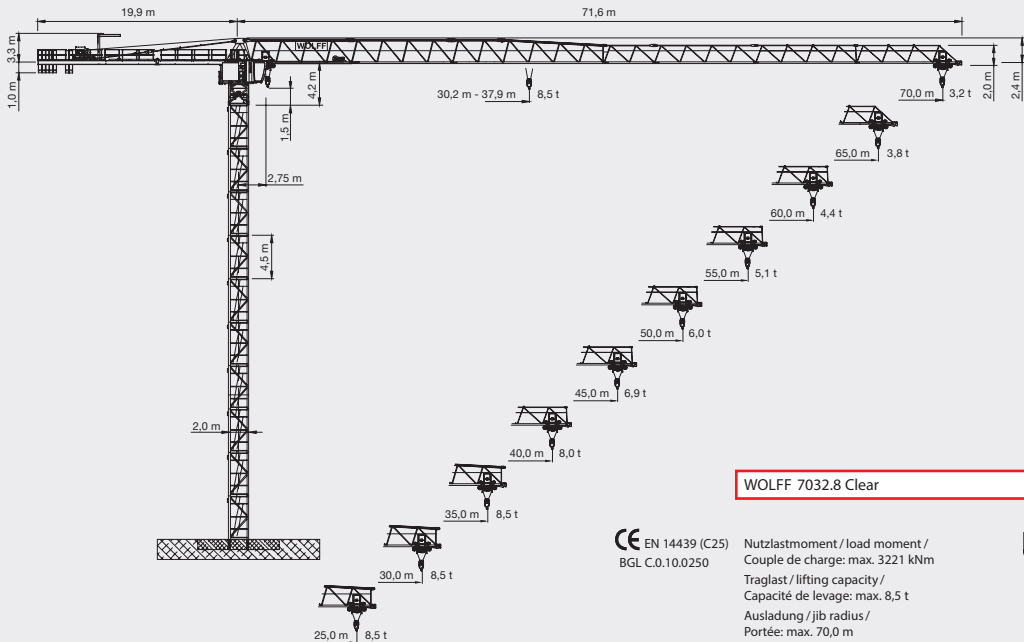

WOLFF 7032.8 Clear

CE EN 14439 (C25) Nutzlastmoment / load moment /
 BGL C.0.10.0250 Couple de charge: max. 3221 kNm
 Traglast / lifting capacity /
 Capacité de levage: max. 8,5 t
 Ausladung / jib radius /
 Portée: max. 70,0 m



WOLFF 7032.8 Clear Turmkombinationen · Tower configurations · Combinaisons de tour

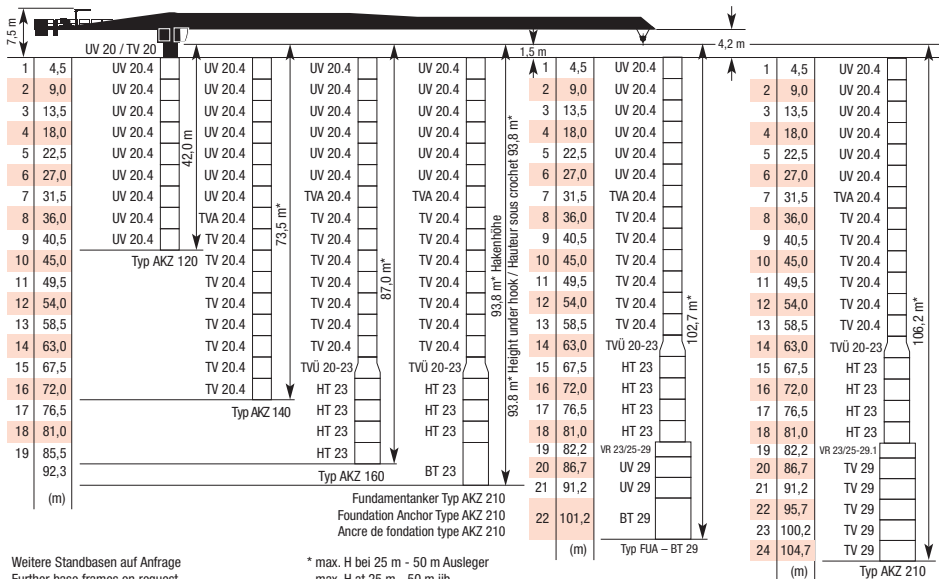

Weitere Standbasen auf Anfrage
Further base frames on request
Pour d'autres bases, nous consulter

* max. H bei 25 m - 50 m Ausleger
max. H at 25 m - 50 m jib
max. H à 25 m - 50 m de flèche

Traglasten (t) · WOLFF 7032.8 Clear
Load Data
Charges

Ausladung (m) / jib radius (m) / Portée (m)		25	27,5	30	32,5	35	37,5	40	42,5	45	47,5	50	52,5	55	57,5	60	62,5	65	67,5	70	
Auslegerlänge (m) / jib length (m) / Longueur de flèche (m)	70,0	2,75 - 30,2	8,5	8,5	8,5	7,9	7,2	6,7	6,2	5,8	5,4	5,1	4,8	4,5	4,3	4,1	3,9	3,7	3,5	3,4	3,2
	67,5	2,75 - 31,3	8,5	8,5	8,5	8,2	7,5	7,0	6,5	6,1	5,7	5,3	5,0	4,7	4,5	4,3	4,0	3,9	3,7	3,5	
	65,0	2,75 - 32,3	8,5	8,5	8,5	8,4	7,8	7,2	6,7	6,3	5,9	5,5	5,2	4,9	4,6	4,4	4,2	4,0	3,8		
	62,5	2,75 - 33,0	8,5	8,5	8,5	8,5	8,0	7,4	6,9	6,4	6,0	5,7	5,3	5,0	4,8	4,5	4,3	4,1			
	60,0	2,75 - 33,6	8,5	8,5	8,5	8,5	8,1	7,5	7,0	6,6	6,1	5,8	5,5	5,2	4,9	4,6	4,4				
	57,5	2,75 - 34,4	8,5	8,5	8,5	8,5	8,3	7,7	7,2	6,7	6,3	5,9	5,6	5,3	5,0	4,8					
	55,0	2,75 - 35,0	8,5	8,5	8,5	8,5	8,5	7,9	7,3	6,8	6,4	6,0	5,7	5,4	5,1						
	52,5	2,75 - 35,6	8,5	8,5	8,5	8,5	8,5	8,0	7,5	7,0	6,6	6,2	5,8	5,5							
	50,0	2,75 - 36,6	8,5	8,5	8,5	8,5	8,5	8,3	7,7	7,2	6,8	6,4	6,0								
	47,5	2,75 - 37,3	8,5	8,5	8,5	8,5	8,5	8,5	7,9	7,4	6,9	6,5									
	45,0	2,75 - 37,3	8,5	8,5	8,5	8,5	8,5	8,5	7,9	7,4	6,9										
	42,5	2,75 - 37,5	8,5	8,5	8,5	8,5	8,5	8,5	7,9	7,4											
	40,0	2,75 - 37,9	8,5	8,5	8,5	8,5	8,5	8,0													
	37,5	2,75 - 37,5	8,5	8,5	8,5	8,5	8,5	8,5													
	35,0	2,75 - 35,0	8,5	8,5	8,5	8,5	8,5														
	32,5	2,75 - 32,5	8,5	8,5	8,5	8,5															
	30,0	2,75 - 30,0	8,5	8,5	8,5																
	27,5	2,75 - 27,5	8,5	8,5																	
	25,0	2,75 - 25,0	8,5																		







8,5 t

Tragfähigkeit (t) / load capacity (t) / Capacité de charge (t)

Antriebe · WOLFF 7032.8 Clear · (Hw 845 FU)

Mechanisms





Mécanismes

				
Motor (kW) motor Moteur	45	7,5	1 x 7,5	2 x 5,5
Geschwindigkeit speed Vitesse	0 - 1,6 t 0...115 m/min stufenlos / stepless / en continue 0 - 8,5 t 0...26 m/min	0 - 3,0 t 0...100 m/min stufenlos / stepless / en continue 0 - 8,5 t 0...65 m/min	0,8 min ⁻¹	25,0 m/min
Hakenweg (m) hook path course du crochet	190			















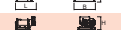

Antriebe · WOLFF 7032.8 Clear · (Hw 875 FU)

Mechanisms

Mécanismes

				
Motor (kW) motor Moteur	75	7,5	1 x 7,5	2 x 5,5
Geschwindigkeit speed Vitesse	0 - 1,7 t 0...185 m/min stufenlos / stepless / en continue 0 - 8,5 t 0...44 m/min	0 - 3,0 t 0...100 m/min stufenlos / stepless / en continue 0 - 8,5 t 0...65 m/min	0,8 min ⁻¹	25,0 m/min
Hakenweg (m) hook path course du crochet	460			

WOLFF 7032.8 Clear Kollli Liste - Colli list - Liste de colisage

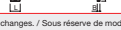
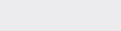
Pos. Pos.	Stk. Pce.	Beschreibung / Description / Description	Kollli / Colli / Colis	L (m) Length Longueur	B (m) Width Largeur	H (m) Height Hauteur	Gewicht (kg) Weight Poids	Volumen (m³) Volume Volume
1	1	Turmspitze komplett / Tower top complete / Pointe de tour complète		6,63	2,62	2,32	10940	40,30
	1	Turmspitzenoberteil / Tower top upper part / Porte-flèche <small>Pos. 1 zerlegt / Item 1 disassembled / Pos. 1 groupe. mit Abstützarmen / with stay parts / avec éléments de haubanage</small>		2,23	0,71	2,20	1775	3,48
	1	Turmspitzenunterteil / Tower top lower part / Pivot tournant <small>Pos. 1 zerlegt / Item 1 disassembled / Pos. 1 groupe</small>		5,27	2,62	2,32	9165	32,03
2	1	Führerhausstation / Operator cabin station / Poste de cabine du grutier <small>mit Führerhausaufhängung und Schaltkasten / with cabin attachment and control cabinet / avec fixation cabine et armoire de distribution</small>		4,73	2,12	2,56	2560	25,67
3	1	Gegenausleger geklappt / Counterjib folded / Contre-flèche repliée <small>mit Ausbaubäumen und Abstützarmen / with auxiliary crane and stay parts / avec grue de démontage et éléments de haubanage</small>		11,97	2,30	2,22	10860	61,12
4	1	Hw845FU Hubwindenplattform / Hoisting gear platform / Plateforme de levage <small>mit Hubseil / with hoist rope / avec le câble de levage (480 m = 925 kg) oben 2. Bremsen / without 2nd brake / sans 2ème frein</small>		1,69	1,72	1,04	2675	4,45
5	1	Hw875FU Hubwindenplattform / Hoisting gear platform / Plateforme de levage <small>mit Hubseil / with hoist rope / avec le câble de levage (520 m = 1285 kg) oben 2. Bremsen / without 2nd brake / sans 2ème frein</small>		1,95	1,68	1,23	3520	4,03
6	1	Auslegerteil 1 / Jib part 1 / Élément de flèche 1		10,30	1,41	2,54	3920	36,89
7	1	Auslegerteil 2 / Jib part 2 / Élément de flèche 2		10,32	1,40	2,50	2380	36,12
8	1	Auslegerteil 3 / Jib part 3 / Élément de flèche 3		5,31	1,40	2,49	1035	18,51
9	1	Auslegerteil 4 / Jib part 4 / Élément de flèche 4		10,26	1,40	2,46	1740	35,34
10	1	Auslegerteil 5 / Jib part 5 / Élément de flèche 5		5,23	1,40	1,92	810	14,06
11	1	Auslegerteil 6 / Jib part 6 / Élément de flèche 6		2,73	1,40	1,92	510	7,34
12	1	Auslegerteil 7 / Jib part 7 / Élément de flèche 7		10,22	1,40	1,92	1370	27,47
13	1	Auslegerteil 8 / Jib part 8 / Élément de flèche 8		10,15	1,40	1,91	1000	27,14
14	1	Auslegerteil 9 / Jib part 9 / Élément de flèche 9		10,16	1,40	1,91	760	27,17
15	1	Seilwirbeltraverse / Rope swivel traverse / Traverse de pointe fixe		0,99	1,35	0,43	145	0,58
16	1	Laufkatze LK 8 / Trolley LK 8 / Chariot de distribution LK 8		1,87	1,60	0,83	330	2,48
17	1	Unterflasche U 6 (8) / Hook block U 6 (8) / Crochet U 6 (8)		0,50	0,22	1,11	350	0,12
18	7	Gegengewichtssteine / Counterweight blocks / Blocs de contrepois		1,41	0,36	2,30	2700	1,17

Technische und inhaltliche Änderungen sind vorbehalten. / All rights reserved regarding technical and content changes. / Sous réserve de modifications techniques et de fond.

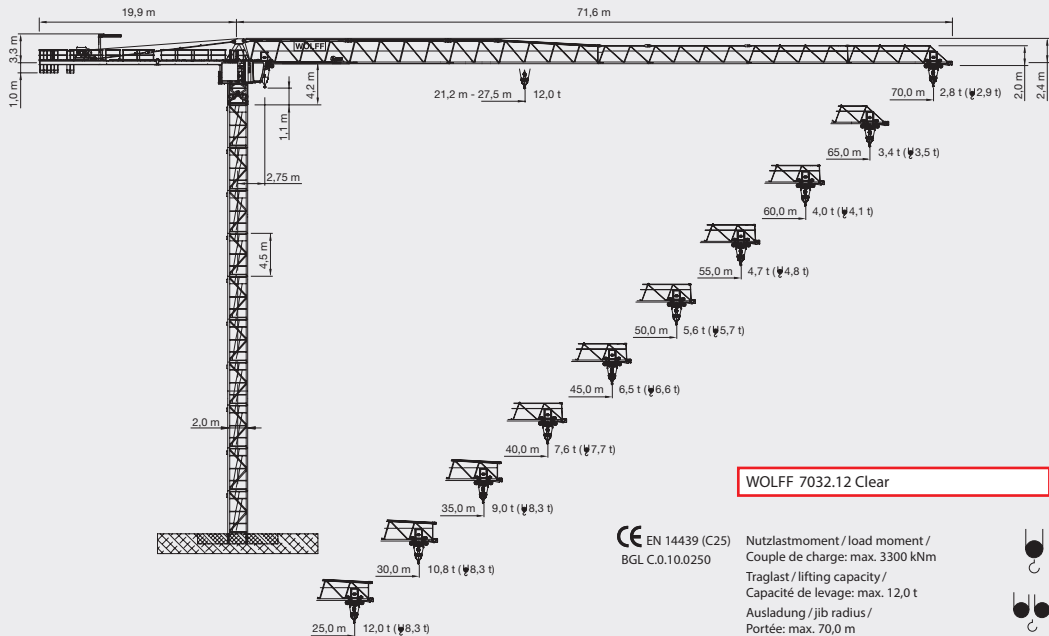

Traglasten (t) • WOLFF 7032.12 Clear
Load Data
Charges

Ausladung (m) / jib radius (m) / Portée (m)		25	27,5	30	32,5	35	37,5	40	42,5	45	47,5	50	52,5	55	57,5	60	62,5	65	67,5	70	
Auslegerlänge (m) / jib length (m) / Longueur de flèche (m)	70,0	2,75 - 29,8	8,3	8,3	8,2	7,5	6,9	6,4	5,9	5,5	5,1	4,8	4,5	4,2	4,0	3,8	3,6	3,4	3,2	3,1	2,9
	67,5	2,75 - 30,9	8,3	8,3	8,3	7,8	7,2	6,6	6,2	5,7	5,4	5,0	4,7	4,4	4,2	4,0	3,7	3,5	3,4	3,2	
	65,0	2,75 - 31,8	8,3	8,3	8,3	8,1	7,4	6,9	6,4	5,9	5,5	5,2	4,9	4,6	4,3	4,1	3,9	3,7	3,5		
	62,5	2,75 - 32,6	8,3	8,3	8,3	8,3	7,7	7,1	6,6	6,1	5,7	5,4	5,0	4,7	4,5	4,2	4,0	3,8			
	60,0	2,75 - 33,2	8,3	8,3	8,3	8,3	7,8	7,2	6,7	6,2	5,8	5,5	5,1	4,8	4,6	4,3	4,1				
	57,5	2,75 - 34,0	8,3	8,3	8,3	8,3	8,0	7,4	6,9	6,4	6,0	5,6	5,3	5,0	4,7	4,5					
	55,0	2,75 - 34,5	8,3	8,3	8,3	8,3	8,2	7,6	7,0	6,5	6,1	5,7	5,4	5,1	4,8						
	52,5	2,75 - 35,2	8,3	8,3	8,3	8,3	8,3	7,7	7,2	6,7	6,3	5,9	5,5	5,2							
	50,0	2,75 - 36,2	8,3	8,3	8,3	8,3	8,3	8,0	7,4	6,9	6,5	6,1	5,7								
	47,5	2,75 - 36,9	8,3	8,3	8,3	8,3	8,3	8,2	7,6	7,1	6,6	6,2									
	45,0	2,75 - 36,9	8,3	8,3	8,3	8,3	8,3	8,1	7,6	7,1	6,6										
	42,5	2,75 - 37,1	8,3	8,3	8,3	8,3	8,3	8,2	7,6	7,1											
	40,0	2,75 - 37,5	8,3	8,3	8,3	8,3	8,3	8,3	7,7												
	37,5	2,75 - 37,5	8,3	8,3	8,3	8,3	8,3	8,3													
	35,0	2,75 - 35,0	8,3	8,3	8,3	8,3	8,3														
	32,5	2,75 - 32,5	8,3	8,3	8,3	8,3															
	30,0	2,75 - 30,0	8,3	8,3	8,3																
27,5	2,75 - 27,5	8,3	8,3																		
25,0	2,75 - 25,0	8,3																			



8,3 t

Tragfähigkeit (t) / load capacity (t) / Capacité de charge (t)

Traglasten (t) · WOLFF 7032.12 Clear
Load Data
Charges

Ausladung (m) / jib radius (m) / Portée (m)		25	27,5	30	32,5	35	37,5	40	42,5	45	47,5	50	52,5	55	57,5	60	62,5	65	67,5	70
Auslegerlänge (m) / jib length (m) / Longueur de flèche (m)	70,0 2,75 - 21,2	10,0	9,0	8,1	7,4	6,8	6,3	5,8	5,4	5,0	4,7	4,4	4,1	3,9	3,7	3,5	3,3	3,1	3,0	2,8
	67,5 2,75 - 22,0	10,4	9,4	8,5	7,7	7,1	6,5	6,1	5,6	5,3	4,9	4,6	4,3	4,1	3,9	3,6	3,4	3,3	3,1	
	65,0 2,75 - 22,7	10,8	9,7	8,8	8,0	7,3	6,8	6,3	5,8	5,4	5,1	4,8	4,5	4,2	4,0	3,8	3,6	3,4		
	62,5 2,75 - 23,2	11,1	9,9	9,0	8,2	7,6	7,0	6,5	6,0	5,6	5,3	4,9	4,6	4,4	4,1	3,9	3,7			
	60,0 2,75 - 23,6	11,3	10,2	9,2	8,4	7,7	7,1	6,6	6,1	5,7	5,4	5,0	4,7	4,5	4,2	4,0				
	57,5 2,75 - 24,2	11,6	10,4	9,4	8,6	7,9	7,3	6,8	6,3	5,9	5,5	5,2	4,9	4,6	4,4					
	55,0 2,75 - 24,6	11,8	10,6	9,6	8,8	8,1	7,5	6,9	6,4	6,0	5,6	5,3	5,0	4,7						
	52,5 2,75 - 25,1	12,0	10,8	9,8	9,0	8,3	7,6	7,1	6,6	6,2	5,8	5,4	5,1							
	50,0 2,75 - 25,8	12,0	11,2	10,1	9,3	8,5	7,9	7,3	6,8	6,4	6,0	5,6								
	47,5 2,75 - 26,3	12,0	11,4	10,4	9,5	8,7	8,1	7,5	7,0	6,5	6,1									
	45,0 2,75 - 26,3	12,0	11,4	10,4	9,5	8,7	8,0	7,5	7,0	6,5										
	42,5 2,75 - 26,4	12,0	11,5	10,4	9,5	8,8	8,1	7,5	7,0											
	40,0 2,75 - 26,7	12,0	11,6	10,5	9,6	8,9	8,2	7,6												
	37,5 2,75 - 26,7	12,0	11,6	10,6	9,7	8,9	8,2													
	35,0 2,75 - 27,1	12,0	11,8	10,7	9,8	9,0														
	32,5 2,75 - 27,1	12,0	11,8	10,7	9,8															
	30,0 2,75 - 27,3	12,0	11,9	10,8																
	27,5 2,75 - 27,5	12,0	12,0																	
	25,0 2,75 - 25,0	12,0																		







Tragfähigkeit (t) / load capacity (t) / Capacité de charge (t)

Antriebe · WOLFF 7032.12 Clear · (Hw 845 FU)

Mechanisms





Mécanismes

					
Motor (kW) motor Moteur	45	45	7,5	1 x 7,5	2 x 5,5
Geschwindigkeit speed Vitesse	0 - 1,3 t 0...115 m/min stufenlos / stepless / en continue 0 - 8,3 t 0...26 m/min	0 - 3,5 t 0...58 m/min stufenlos / stepless / en continue 0 - 12,0 t 0...18 m/min	0 - 3,0 t 0...100 m/min stufenlos / stepless / en continue 0 - 8,3 t 0...65 m/min 0 - 12,0 t 0...40 m/min	0,8 min ⁻¹	25,0 m/min
Hakenweg (m) hook path course du crochet	190	95			













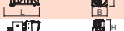





Antriebe · WOLFF 7032.12 Clear · (Hw 875 FU)

Mechanisms

Mécanismes

					
Motor (kW) motor Moteur	75	75	7,5	1 x 7,5	2 x 5,5
Geschwindigkeit speed Vitesse	0 - 1,5 t 0...185 m/min stufenlos / stepless / en continue 0 - 8,3 t 0...44 m/min	0 - 3,6 t 0...93 m/min stufenlos / stepless / en continue 0 - 12,0 t 0...31 m/min	0 - 3,0 t 0...100 m/min stufenlos / stepless / en continue 0 - 8,3 t 0...65 m/min 0 - 12,0 t 0...40 m/min	0,8 min ⁻¹	25,0 m/min
Hakenweg (m) hook path course du crochet	460	230			

WOLFF 7032.12 Clear Kollif Liste · Colli list · Liste de colisage

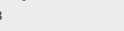
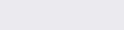
Pos. Pos. Pos.	Stück. Pce. Pcs.	Beschreibung / Description / Description	Kolli / Colli / Colis	L (m) Length Longueur	B (m) Width Largeur	H (m) Height Hauteur	Gewicht (kg) Weight Poids	Volumen (m³) Volume Volume
1	1	Turmspitze komplett / Tower top complete / Pointe de tour complète		6,63	2,62	2,32	10940	40,30
	1	Turmspitzenoberteil / Tower top upper part / Porte-flèche <small>Pos. 1 zerlegt / Item 1 disassembled / Pos. 1 groups mit Absperrklappen / with stay parts / avec éléments de haubannage</small>		2,23	0,71	2,20	1775	3,48
	1	Turmspitzenunterteil / Tower top lower part / Pivot tournant <small>Pos. 1 zerlegt / Item 1 disassembled / Pos. 1 groups</small>		5,27	2,62	2,32	9165	32,03
2	1	Führerhausstation / Operator cabin station / Poste de cabine du grutier <small>mit Führerhausabzug und Schaltschrank / with cabin attachment and control cabinet / avec fixation cabine et armoire de distribution</small>		4,73	2,12	2,56	2560	25,67
3	1	Gegenausleger geklappt / Counterjib folded / Contre-flèche repliée <small>mit Ausbaubremse und Absperrklappen / with auxiliary crane and stay parts / avec gear de démontage et éléments de haubannage</small>		11,97	2,30	2,22	10860	61,12
4	1	Hw845FU Hubwindenplattform / Hoisting gear platform / Plateforme de levage <small>mit Hubseil / with hoist rope / avec le câble de levage (450 m = 605 kg) ohne 2. Bremsen / without 2nd brake / sans 2ème frein</small>		1,69	1,72	1,04	2675	4,45
5	1	Hw875FU Hubwindenplattform / Hoisting gear platform / Plateforme de levage <small>mit Hubseil / with hoist rope / avec le câble de levage (520 m = 1285 kg) ohne 2. Bremsen / without 2nd brake / sans 2ème frein</small>		1,95	1,68	1,23	3520	4,03
6	1	Auslegerteil 1 / Jib part 1 / Élément de flèche 1		10,30	1,41	2,54	3920	36,89
7	1	Auslegerteil 2 / Jib part 2 / Élément de flèche 2		10,32	1,40	2,50	2380	36,12
8	1	Auslegerteil 3 / Jib part 3 / Élément de flèche 3		5,31	1,40	2,49	1035	18,51
9	1	Auslegerteil 4 / Jib part 4 / Élément de flèche 4		10,26	1,40	2,46	1740	35,34
10	1	Auslegerteil 5 / Jib part 5 / Élément de flèche 5		5,23	1,40	1,92	810	14,06
11	1	Auslegerteil 6 / Jib part 6 / Élément de flèche 6		2,73	1,40	1,92	510	7,34
12	1	Auslegerteil 7 / Jib part 7 / Élément de flèche 7		10,22	1,40	1,92	1370	27,47
13	1	Auslegerteil 8 / Jib part 8 / Élément de flèche 8		10,15	1,40	1,91	1000	27,14
14	1	Auslegerteil 9 / Jib part 9 / Élément de flèche 9		10,16	1,40	1,91	760	27,17
15	1	Seilwirbeltraverse / Rope swivel traverse / Traverse de pointe fixe		0,99	1,35	0,43	145	0,58
16	1	Laufkatze LK 8/12 / Trolley LK 8/12 / Chariot de distribution LK 8/12		1,87	1,60	1,13	390	3,38
17	1	Unterflasche U 8/16 AU / Hook block U 8/16 AU / Crochet U 8/16 AU		1,02	0,27	1,84	550	0,51
18	7	Gegengewichtssteine / Counterweight blocks / Blocs de contrepois		1,41	0,36	2,30	2700	1,17

Technische und inhaltliche Änderungen sind vorbehalten. / All rights reserved regarding technical and content changes. / Sous réserve de modifications techniques et de fond.

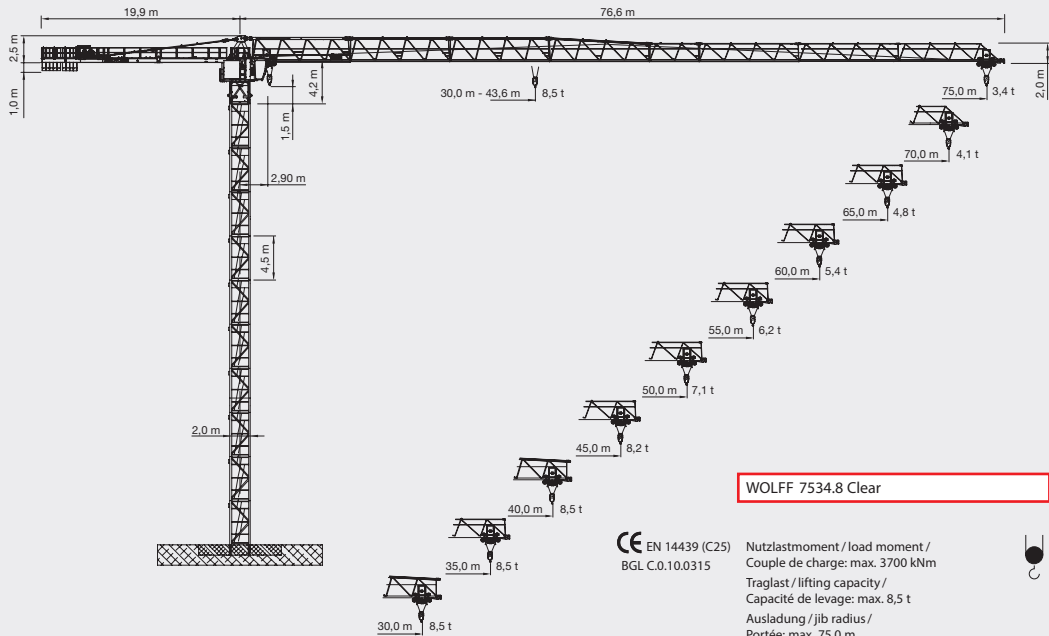

WOLFF 7534.8 Clear Turmkombinationen · Tower configurations · Combinaisons de tour

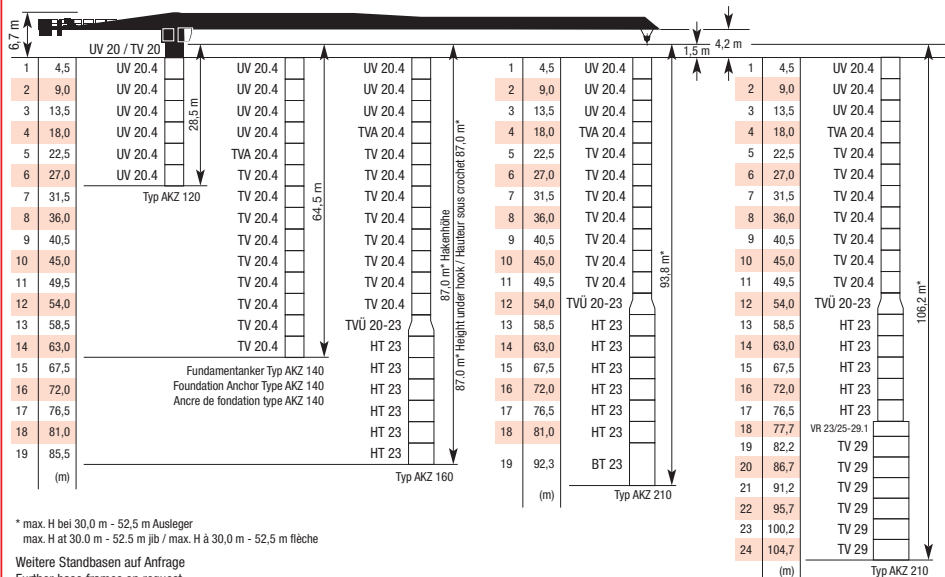

* max. H bei 30,0 m - 52,5 m Ausleger
 max. H at 30.0 m - 52.5 m jib / max. H à 30,0 m - 52,5 m flèche

Weitere Standbasen auf Anfrage
 Further base frames on request
 Pour d'autres bases, nous consulter

Traglasten (t) · WOLFF 7534.8 Clear

Load Data

Charges

Ausladung(m) / jibradius(m) / Portée(m)		20,0	25,0	27,5	30,0	32,5	35,0	37,5	40,0	42,5	45,0	47,5	50,0	52,5	55,0	57,5	60,0	62,5	65,0	67,5	70,0	72,5	75,0	
Auslegerlänge (m) / jib length (m) / Longueur de flèche (m)	75,0 2,9 - 34,2	8,5	8,5	8,5	8,5	8,5	8,3	7,7	7,1	6,7	6,3	5,9	5,5	5,2	5,0	4,7	4,5	4,3	4,1	3,9	3,7	3,6	3,4	
	72,5 2,9 - 35,4	8,5	8,5	8,5	8,5	8,5	8,5	8,0	7,4	6,9	6,5	6,1	5,8	5,4	5,2	4,9	4,7	4,4	4,2	4,0	3,9	3,7		
	70,0 2,9 - 37,1	8,5	8,5	8,5	8,5	8,5	8,5	8,4	7,8	7,3	6,9	6,5	6,1	5,8	5,5	5,2	4,9	4,7	4,5	4,3	4,1			
	67,5 2,9 - 38,0	8,5	8,5	8,5	8,5	8,5	8,5	8,5	8,0	7,5	7,0	6,6	6,2	5,9	5,6	5,3	5,1	4,8	4,6	4,4				
	65,0 2,9 - 39,3	8,5	8,5	8,5	8,5	8,5	8,5	8,5	8,3	7,8	7,3	6,9	6,5	6,2	5,8	5,5	5,3	5,0	4,8					
	62,5 2,9 - 39,8	8,5	8,5	8,5	8,5	8,5	8,5	8,5	8,5	7,9	7,4	7,0	6,6	6,2	5,9	5,6	5,4	5,1						
	60,0 2,9 - 40,1	8,5	8,5	8,5	8,5	8,5	8,5	8,5	8,5	8,0	7,5	7,1	6,7	6,3	6,0	5,7	5,4							
	57,5 2,9 - 40,9	8,5	8,5	8,5	8,5	8,5	8,5	8,5	8,5	8,2	7,7	7,2	6,8	6,4	6,1	5,8								
	55,0 2,9 - 41,5	8,5	8,5	8,5	8,5	8,5	8,5	8,5	8,5	8,3	7,8	7,3	6,9	6,5	6,2									
	52,5 2,9 - 42,4	8,5	8,5	8,5	8,5	8,5	8,5	8,5	8,5	8,5	8,0	7,5	7,1	6,7										
	50,0 2,9 - 42,5	8,5	8,5	8,5	8,5	8,5	8,5	8,5	8,5	8,5	8,0	7,5	7,1											
	47,5 2,9 - 43,4	8,5	8,5	8,5	8,5	8,5	8,5	8,5	8,5	8,5	8,2	7,7												
	45,0 2,9 - 43,6	8,5	8,5	8,5	8,5	8,5	8,5	8,5	8,5	8,5	8,2													
	42,5 2,9 - 42,5	8,5	8,5	8,5	8,5	8,5	8,5	8,5	8,5	8,5														
	40,0 2,9 - 40,0	8,5	8,5	8,5	8,5	8,5	8,5	8,5	8,5															
	37,5 2,9 - 37,5	8,5	8,5	8,5	8,5	8,5	8,5	8,5																
	35,0 2,9 - 35,0	8,5	8,5	8,5	8,5	8,5																		
32,5 2,9 - 32,5	8,5	8,5	8,5	8,5	8,5																			
30,0 2,9 - 30,0	8,5	8,5	8,5	8,5																				







8,5 t

Tragfähigkeit (t) / load capacity (t) / Capacité de charge (t)

Antriebe · WOLFF 7534.8 Clear · (Hw 845 FU)

Mechanisms





Mécanismes

				
Motor (kW) motor Moteur	45	9,0	2 x 6,0	2 x 5,5
Geschwindigkeit speed Vitesse	0 - 1,6 t 0 ... 115 m/min stufenlos / stepless / en continue 0 - 8,5 t 0 ... 26 m/min	0 - 3,0 t 0 ... 100 m/min stufenlos / stepless / en continue 0 - 8,5 t 0 ... 65 m/min	0,80 min ⁻¹	25,0 m/min
Hakenweg (m) hook path course du crochet	190			





















Antriebe · WOLFF 7534.8 Clear · (Hw 875 FU)

Mechanisms

Mécanismes

				
Motor (kW) motor Moteur	75	9,0	2 x 6,0	2 x 5,5
Geschwindigkeit speed Vitesse	0 - 1,7 t 0 ... 185 m/min stufenlos / stepless / en continue 0 - 8,5 t 0 ... 44 m/min	0 - 3,0 t 0 ... 100 m/min stufenlos / stepless / en continue 0 - 8,5 t 0 ... 65 m/min	0,80 min ⁻¹	25,0 m/min
Hakenweg (m) hook path course du crochet	460			

WOLFF 7534.8 Clear Kolli Liste - Colli List - Liste de colisage

Pos. Pos. Pos.	Stck. Pce. Pcs.	Beschreibung / Description / Description	Kolli / Colli / Colis	L [m] Length Longueur	B [m] Width Largeur	H [m] Height Hauteur	Gewicht [kg] Weight Poids	Volumen [m ³] Volume Volume
1	1	Turmspitze komplett / Tower top complete / Pointe de tour complète mit Abzugsteilen / with stay parts / avec éléments de haubanage		6,79	2,65	2,33	11657	41,92
	1	Turmspitzenoberteil / Tower top upper part / Porte-fleche Pos. 1 zerlegt / Item 1 disassembled / Pos. 1 groupe mit Abzugsteilen / with stay parts / avec éléments de haubanage		2,25	0,77	2,27	1837	3,93
	1	Turmspitzenunterteil / Tower top lower part / Pivot tournant Pos. 1 zerlegt / Item 1 disassembled / Pos. 1 groupe		5,12	2,65	2,33	9820	31,61
2	1	Führerhaustation / Operator cabin station / Poste de cabine du grutier mit Führerhausabhängung und Schubbalken / with operator's cabin stand and control cabinet / avec l'habitation, cabine et armé de distribution		4,77	2,16	2,56	2830	26,38
3	1	Gegenausleger geklappt / Counterjib folded / Contre-fleche repliée mit Ausbaubremse und Blöcken / with auxiliary brake and blocks / avec grand démontage et éléments de haubanage		11,88	2,30	2,25	11685	61,48
4	1	Hw 845 FU Hubwindenplattform / Hoisting gear platform / Plateforme de levage mit Hubseil / with hoist rope / avec câble de levage (485 m + 810 kg) ohne 2. Bremse / without 2nd brake / sans 2ème frein		1,69	1,72	1,04	3680	4,45
5	1	Hw 875 FU Hubwindenplattform / Hoisting gear platform / Plateforme de levage mit Hubseil / with hoist rope / avec câble de levage (1025 m + 1290 kg) ohne 2. Bremse / without 2nd brake / sans 2ème frein		1,95	1,68	1,23	4485	4,03
6	1	Auslegerteil 1 / Jib part 1 / Élément de fleche 1		10,33	1,46	2,59	4570	39,06
7	1	Auslegerteil 2 / Jib part 2 / Élément de fleche 2		10,42	1,40	2,55	2840	37,20
8	1	Auslegerteil 3 / Jib part 3 / Élément de fleche 3		10,44	1,40	2,52	2260	36,83
9	1	Auslegerteil 4 / Jib part 4 / Élément de fleche 4		10,41	1,40	2,48	1890	36,14
10	1	Auslegerteil 5 / Jib part 5 / Élément de fleche 5		5,38	1,40	1,93	830	14,54
11	1	Auslegerteil 6 / Jib part 6 / Élément de fleche 6		2,87	1,40	1,94	480	7,80
12	1	Auslegerteil 7 / Jib part 7 / Élément de fleche 7		10,36	1,40	1,93	1520	27,85
13	1	Auslegerteil 8 / Jib part 8 / Élément de fleche 8		10,34	1,40	1,92	1040	27,79
14	1	Auslegerteil 9 / Jib part 9 / Élément de fleche 9		10,30	1,40	1,91	800	27,54
15	1	Selwirltraverse / Rope swivel traverse / Traverse de pointe fixe		0,99	1,38	0,46	170	0,63
16	1	Laufkatze LK 8 / Trolley LK 8 / Chariot de distribution LK 8		1,87	1,64	0,97	415	2,98
17	1	Unterflasche UB / Hook block UB / Crochet UB		0,52	0,19	1,11	345	0,11
18	9	Gegengewichtsteine / Counterweight blocks / Blocs de contrepoids		1,41	0,36	2,28	2700	1,16

Technische und inhaltliche Änderungen sind vorbehalten. / All rights reserved regarding technical and content changes. / Sous réserve de modifications techniques et de fond.

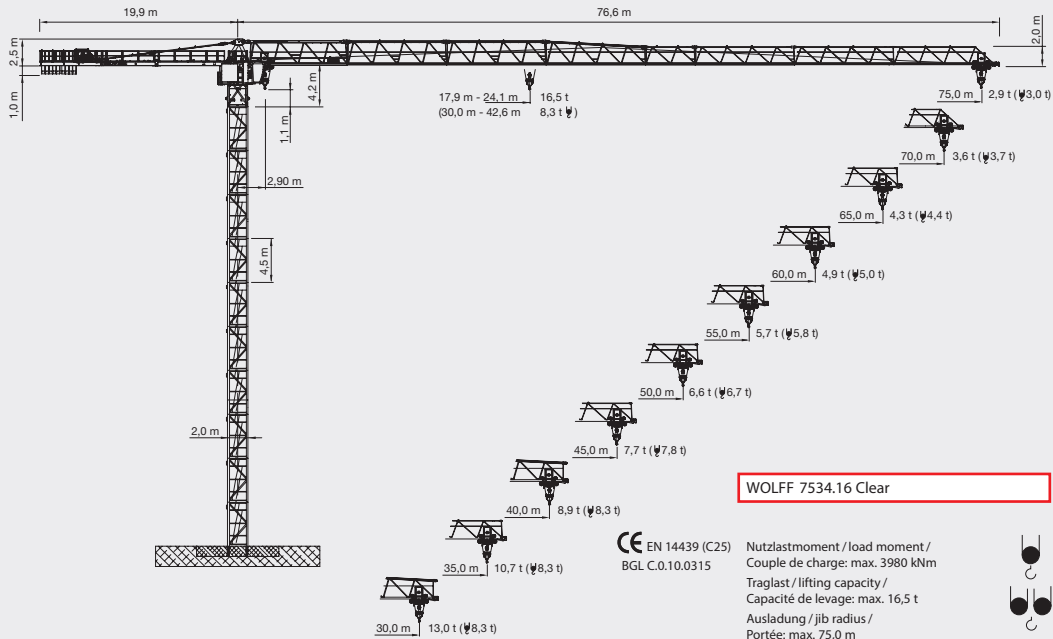

WOLFF 7534.16 Clear Turmkombinationen - Tower configurations - Combinaisons de tour

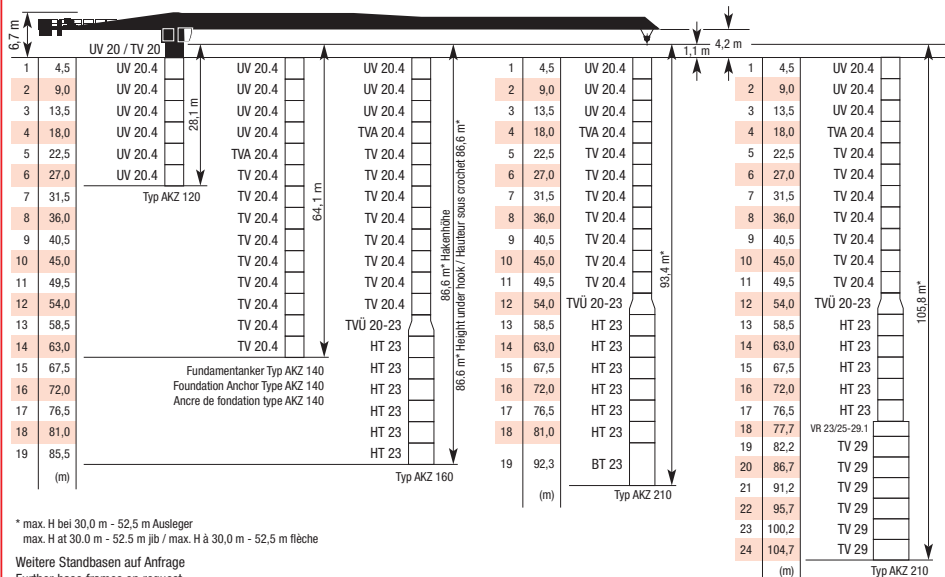

* max. H bei 30,0 m - 52,5 m Ausleger

max. H at 30.0 m - 52.5 m jib / max. H à 30,0 m - 52,5 m flèche

Weitere Standbasen auf Anfrage

Further base frames on request

Pour d'autres bases, nous consulter

Traglasten (t) · WOLFF 7534.16 Clear

Load Data

Charges

Ausladung(m) / jibradius(m) / Portée(m)		20,0	25,0	27,5	30,0	32,5	35,0	37,5	40,0	42,5	45,0	47,5	50,0	52,5	55,0	57,5	60,0	62,5	65,0	67,5	70,0	72,5	75,0	
Auslegerlänge (m) / jib length (m) / Longueur de flèche (m)	75,0 2,9 - 33,5	8,3	8,3	8,3	8,3	8,3	7,9	7,3	6,7	6,3	5,9	5,5	5,1	4,8	4,6	4,3	4,1	3,9	3,7	3,5	3,3	3,2	3,0	
	72,5 2,9 - 34,6	8,3	8,3	8,3	8,3	8,3	8,2	7,6	7,0	6,5	6,1	5,7	5,4	5,0	4,8	4,5	4,3	4,0	3,8	3,6	3,5	3,3		
	70,0 2,9 - 36,4	8,3	8,3	8,3	8,3	8,3	8,3	8,0	7,4	6,9	6,5	6,1	5,7	5,4	5,1	4,8	4,5	4,3	4,1	3,9	3,7			
	67,5 2,9 - 37,2	8,3	8,3	8,3	8,3	8,3	8,3	8,2	7,6	7,1	6,6	6,2	5,8	5,5	5,2	4,9	4,7	4,4	4,2	4,0				
	65,0 2,9 - 38,5	8,3	8,3	8,3	8,3	8,3	8,3	8,3	7,9	7,4	6,9	6,5	6,1	5,8	5,4	5,1	4,9	4,6	4,4					
	62,5 2,9 - 39,0	8,3	8,3	8,3	8,3	8,3	8,3	8,3	8,1	7,5	7,0	6,6	6,2	5,8	5,5	5,2	5,0	4,7						
	60,0 2,9 - 39,3	8,3	8,3	8,3	8,3	8,3	8,3	8,3	8,1	7,6	7,1	6,7	6,3	5,9	5,6	5,3	5,0							
	57,5 2,9 - 40,1	8,3	8,3	8,3	8,3	8,3	8,3	8,3	8,3	7,8	7,3	6,8	6,4	6,0	5,7	5,4								
	55,0 2,9 - 40,6	8,3	8,3	8,3	8,3	8,3	8,3	8,3	8,3	7,9	7,4	6,9	6,5	6,1	5,8									
	52,5 2,9 - 41,5	8,3	8,3	8,3	8,3	8,3	8,3	8,3	8,3	8,1	7,6	7,1	6,7	6,3										
	50,0 2,9 - 41,6	8,3	8,3	8,3	8,3	8,3	8,3	8,3	8,3	8,1	7,6	7,1	6,7											
	47,5 2,9 - 42,5	8,3	8,3	8,3	8,3	8,3	8,3	8,3	8,3	8,3	7,8	7,3												
	45,0 2,9 - 42,6	8,3	8,3	8,3	8,3	8,3	8,3	8,3	8,3	8,3	7,8													
	42,5 2,9 - 42,5	8,3	8,3	8,3	8,3	8,3	8,3	8,3	8,3	8,3														
	40,0 2,9 - 40,0	8,3	8,3	8,3	8,3	8,3	8,3	8,3	8,3															
	37,5 2,9 - 37,5	8,3	8,3	8,3	8,3	8,3	8,3	8,3																
	35,0 2,9 - 35,0	8,3	8,3	8,3	8,3	8,3																		
32,5 2,9 - 32,5	8,3	8,3	8,3	8,3																				
30,0 2,9 - 30,0	8,3	8,3	8,3																					



8,3 t

Tragfähigkeit (t) / load capacity (t) / Capacité de charge (t)

Traglasten (t) · WOLFF 7534.16 Clear

Load Data

Charges

Ausladung(m)/jibradius(m)/Portée(m)		20,0	25,0	27,5	30,0	32,5	35,0	37,5	40,0	42,5	45,0	47,5	50,0	52,5	55,0	57,5	60,0	62,5	65,0	67,5	70,0	72,5	75,0	
Auslegerlänge (m) / jib length (m) / Longueur de flèche (m)	75,0 2,9 - 17,9	14,6	11,4	10,3	9,3	8,5	7,8	7,2	6,6	6,2	5,8	5,4	5,0	4,7	4,5	4,2	4,0	3,8	3,6	3,4	3,2	3,1	2,9	
	72,5 2,9 - 18,5	15,2	11,9	10,7	9,7	8,8	8,1	7,5	6,9	6,4	6,0	5,6	5,3	4,9	4,7	4,4	4,2	3,9	3,7	3,5	3,4	3,2		
	70,0 2,9 - 19,5	16,0	12,6	11,3	10,2	9,3	8,6	7,9	7,3	6,8	6,4	6,0	5,6	5,3	5,0	4,7	4,4	4,2	4,0	3,8	3,6			
	67,5 2,9 - 19,9	16,4	12,9	11,6	10,5	9,6	8,8	8,1	7,5	7,0	6,5	6,1	5,7	5,4	5,1	4,8	4,6	4,3	4,1	3,9				
	65,0 2,9 - 20,6	16,5	13,4	12,0	10,9	10,0	9,2	8,5	7,8	7,3	6,8	6,4	6,0	5,7	5,3	5,0	4,8	4,5	4,3					
	62,5 2,9 - 20,9	16,5	13,6	12,2	11,1	10,1	9,3	8,6	8,0	7,4	6,9	6,5	6,1	5,7	5,4	5,1	4,9	4,6						
	60,0 2,9 - 21,1	16,5	13,7	12,3	11,2	10,2	9,4	8,7	8,0	7,5	7,0	6,6	6,2	5,8	5,5	5,2	4,9							
	57,5 2,9 - 21,5	16,5	14,0	12,6	11,4	10,4	9,6	8,9	8,2	7,7	7,2	6,7	6,3	5,9	5,6	5,3								
	55,0 2,9 - 21,8	16,5	14,2	12,8	11,6	10,6	9,7	9,0	8,4	7,8	7,3	6,8	6,4	6,0	5,7									
	52,5 2,9 - 22,2	16,5	14,5	13,1	11,9	10,9	10,0	9,2	8,6	8,0	7,5	7,0	6,6	6,2										
	50,0 2,9 - 22,3	16,5	14,6	13,1	11,9	10,9	10,0	9,3	8,6	8,0	7,5	7,0	6,6											
	47,5 2,9 - 22,8	16,5	14,9	13,4	12,2	11,2	10,3	9,5	8,8	8,2	7,7	7,2												
	45,0 2,9 - 22,8	16,5	15,0	13,5	12,2	11,2	10,3	9,5	8,8	8,2	7,7													
	42,5 2,9 - 23,0	16,5	15,1	13,6	12,3	11,3	10,4	9,6	8,9	8,3														
	40,0 2,9 - 23,0	16,5	15,1	13,6	12,3	11,3	10,4	9,6	8,9															
	37,5 2,9 - 23,4	16,5	15,4	13,9	12,6	11,5	10,6	9,8																
35,0 2,9 - 23,6	16,5	15,5	14,0	12,7	11,6	10,7																		
32,5 2,9 - 24,0	16,5	15,8	14,2	12,9	11,8																			
30,0 2,9 - 24,1	16,5	15,9	14,3	13,0																				







16,5 t

Tragfähigkeit (t) / load capacity (t) / Capacité de charge (t)

Antriebe · WOLFF 7534.16 Clear · (Hw 845 FU)

Mechanisms





Mécanismes

					
Motor (kW) motor Moteur	45	45	9,0	2 x 6,0	2 x 5,5
Geschwindigkeit speed Vitesse	0 - 1,3 t 0 ... 115 m/min stufenlos / stepless / en continue 0 - 8,3 t 0 ... 26 m/min	0 - 3,4 t 0 ... 58 m/min stufenlos / stepless / en continue 0 - 16,5 t 0 ... 14 m/min	0 - 3,0 t 0 ... 100 m/min stufenlos / stepless / en continue 0 - 8,3 t 0 ... 65 m/min 0 - 16,5 t 0 ... 32 m/min	0,80 min ⁻¹	25,0 m/min
Hakenweg (m) hook path course du crochet	190	95			









































Antriebe · WOLFF 7534.16 Clear · (Hw 875 FU)

Mechanisms

Mécanismes

					
Motor (kW) motor Moteur	75	75	9,0	2 x 6,0	2 x 5,5
Geschwindigkeit speed Vitesse	0 - 1,5 t 0 ... 185 m/min stufenlos / stepless / en continue 0 - 8,3 t 0 ... 44 m/min	0 - 3,6 t 0 ... 94 m/min stufenlos / stepless / en continue 0 - 16,5 t 0 ... 23 m/min	0 - 3,0 t 0 ... 100 m/min stufenlos / stepless / en continue 0 - 8,3 t 0 ... 65 m/min 0 - 16,5 t 0 ... 32 m/min	0,80 min ⁻¹	25,0 m/min
Hakenweg (m) hook path course du crochet	460	230			

WOLFF 7534.16 Clear Kolli Liste - Colli List - Liste de colissage

Pos. Pos.	Stck. Pce. Pcs.	Beschreibung / Description / Description	Kolli / Colli / Colis	L [m] Length Longueurs	B [m] Width Largeur	H [m] Height Hauteur	Gewicht [kg] Weight Poids	Volumen [m ³] Volume Volume	
1	1	Turmspitze komplett / Tower top complete / Pointe de tour complete mit Abgipferlatten / with stay parts / avec éléments de haubertage			6,79	2,65	2,33	11657	41,92
	1	Turmspitzenoberteil / Tower top upper part / Porte-fleche Pos. 1 zerlegt / Item 1 disassembled / Pos. 1 groupe mit Abgipferlatten / with stay parts / avec éléments de haubertage			2,25	0,77	2,27	1837	3,93
	1	Turmspitzenunterteil / Tower top lower part / Pivot tournant Pos. 1 zerlegt / Item 1 disassembled / Pos. 1 groupe			5,12	2,65	2,33	9820	31,61
2	1	Führerhausstation / Operator cabin station / Poste de cabine du grutier mit Führerhausaufhängungs- und Schutzeinrichtungen / with attachment and control devices / avec fixation cabine et armatures de protection			4,77	2,16	2,56	2830	26,38
3	1	Gegenausleger geklappt / Counterjib folded / Contre-fleche repliée mit Ausbauelementen / disassembled / avec éléments de haubertage			11,88	2,30	2,25	11685	61,48
4	1	Hw 845 FU Hubwindenplattform / Hoisting gear platform / Plateforme de levage mit Hubseil / with hoist rope / avec le câble de levage (460 mm x 610 kg) ohne 2. Bremsseil / without 2nd brake / sans 2ème frein			1,69	1,72	1,04	3680	4,45
5	1	Hw 875 FU Hubwindenplattform / Hoisting gear platform / Plateforme de levage mit Hubseil / with hoist rope / avec le câble de levage (1025 mm x 1290 kg) ohne 2. Bremsseil / without 2nd brake / sans 2ème frein			1,95	1,68	1,23	4485	4,03
6	1	Auslegerteil 1 / Jib part 1 / Élément de fleche 1			10,33	1,46	2,59	4570	39,06
7	1	Auslegerteil 2 / Jib part 2 / Élément de fleche 2			10,42	1,40	2,55	2840	37,20
8	1	Auslegerteil 3 / Jib part 3 / Élément de fleche 3			10,44	1,40	2,52	2260	36,83
9	1	Auslegerteil 4 / Jib part 4 / Élément de fleche 4			10,41	1,40	2,48	1890	36,14
10	1	Auslegerteil 5 / Jib part 5 / Élément de fleche 5			5,38	1,40	1,93	830	14,54
11	1	Auslegerteil 6 / Jib part 6 / Élément de fleche 6			2,87	1,40	1,94	480	7,80
12	1	Auslegerteil 7 / Jib part 7 / Élément de fleche 7			10,36	1,40	1,93	1520	27,85
13	1	Auslegerteil 8 / Jib part 8 / Élément de fleche 8			10,34	1,40	1,92	1040	27,79
14	1	Auslegerteil 9 / Jib part 9 / Élément de fleche 9			10,30	1,40	1,91	800	27,54
15	1	Seilwirbeltraverse / Rope swivel traverse / Traverse de pointe fixe			0,99	1,38	0,46	170	0,63
16	1	Laufkatze LK 8/16 / Trolley LK 8/16 / Chariot de distribution LK 8/16			1,87	2,01	1,15	545	4,32
17	1	Unterflasche UB/16 / Hook block UB/16 / Crochet UB/16			1,02	0,27	1,84	630	0,51
18	9	Gegengewichtssteine / Counterweight blocks / Blocs de contrepoids			1,41	0,36	2,28	2700	1,16

Technische und inhaltliche Änderungen sind vorbehalten. / All rights reserved regarding technical and content changes. / Sous réserve de modifications techniques et de fond.

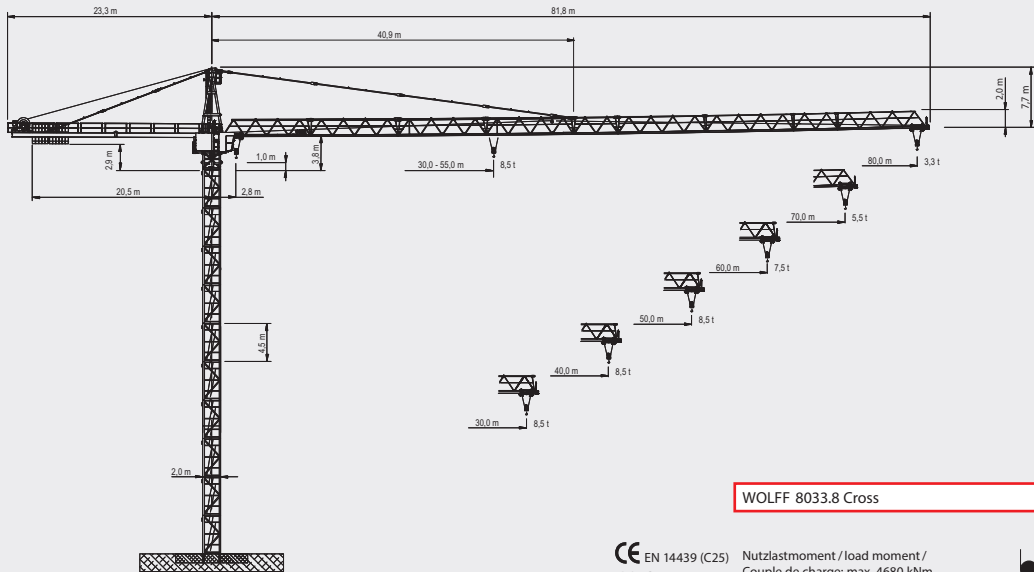

WOLFF 8033.8 Cross

CE EN 14439 (C25) Nutzlastmoment / load moment /
 BGL C.0.10.0450 Couple de charge: max. 4680 kNm
 Traglast / lifting capacity /
 Capacité de levage: max. 8,5 t
 Ausladung / jib radius /
 Portée: max. 80,0 m



WOLFF 8033.8 Cross Turmkombinationen - Tower configurations - Combinaisons de tour

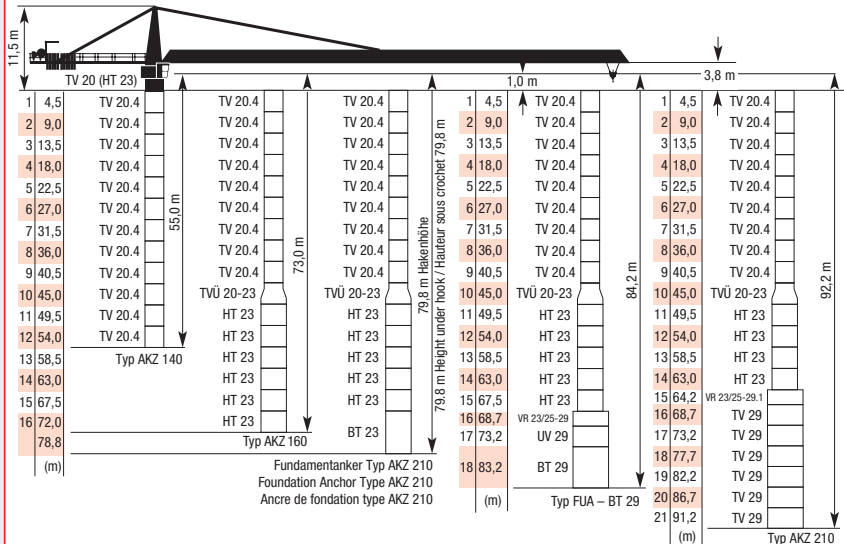

Weitere Standbasen auf Anfrage / Further base frames on request / Pour d'autres bases, nous consulter

Traglasten (t) · WOLFF 8033.8 Cross

Load Data

Charges





Ausladung (m) / jib radius (m) / Portée (m)		30	32,5	35	37,5	40	42,5	45	47,5	50	52,5	55	57,5	60	62,5	65	67,5	70	72,5	75	77,5	80	
Auslegerlänge (m) / jib length (m) / Longueur de flèche (m)	80,0	2,8 – 36,2	8,5	8,5	8,5	8,2	7,6	7,1	6,6	6,2	5,9	5,6	5,3	5,0	4,7	4,5	4,3	4,1	3,9	3,7	3,6	3,4	3,3
	77,5	2,8 – 39,9	8,5	8,5	8,5	8,5	7,9	7,4	7,0	6,6	6,2	5,9	5,6	5,3	5,1	4,8	4,6	4,4	4,2	4,1	3,9		
	75,0	2,8 – 43,4	8,5	8,5	8,5	8,5	8,5	8,2	7,7	7,3	6,9	6,5	6,2	5,9	5,6	5,3	5,1	4,9	4,7	4,5			
	72,5	2,8 – 45,8	8,5	8,5	8,5	8,5	8,5	8,5	8,2	7,7	7,3	6,9	6,6	6,3	6,0	5,7	5,4	5,2	5,0				
	70,0	2,8 – 47,9	8,5	8,5	8,5	8,5	8,5	8,5	8,5	8,1	7,7	7,3	6,9	6,6	6,3	6,0	5,7	5,5					
	67,5	2,8 – 49,7	8,5	8,5	8,5	8,5	8,5	8,5	8,5	8,5	8,0	7,6	7,2	6,9	6,6	6,3	6,0						
	65,0	2,8 – 51,3	8,5	8,5	8,5	8,5	8,5	8,5	8,5	8,5	8,3	7,9	7,5	7,1	6,8	6,5							
	62,5	2,8 – 52,6	8,5	8,5	8,5	8,5	8,5	8,5	8,5	8,5	8,5	8,1	7,7	7,3	7,0								
	60,0	2,8 – 53,7	8,5	8,5	8,5	8,5	8,5	8,5	8,5	8,5	8,5	8,3	7,9	7,5									
	57,5	2,8 – 54,5	8,5	8,5	8,5	8,5	8,5	8,5	8,5	8,5	8,5	8,4	8,0										
	55,0	2,8 – 55,0	8,5	8,5	8,5	8,5	8,5	8,5	8,5	8,5	8,5	8,5											
	52,5	2,8 – 52,5	8,5 t	8,5	8,5	8,5	8,5	8,5	8,5	8,5	8,5	8,5											
	50,0	2,8 – 50,0	8,5	8,5	8,5	8,5	8,5	8,5	8,5	8,5	8,5												
	47,5	2,8 – 47,5	8,5	8,5	8,5	8,5	8,5	8,5	8,5														
	45,0	2,8 – 45,0	8,5	8,5	8,5	8,5	8,5	8,5															
	42,5	2,8 – 42,5	8,5	8,5	8,5	8,5	8,5																
	40,0	2,8 – 40,0	8,5	8,5	8,5	8,5	8,5																
	37,5	2,8 – 37,5	8,5	8,5	8,5	8,5																	
	35,0	2,8 – 35,0	8,5	8,5	8,5																		
	32,5	2,8 – 32,5	8,5	8,5																			
30,0	2,8 – 30,0	8,5																					

Tragfähigkeit (t) / load capacity (t) / Capacité de charge (t)





















Antriebe · WOLFF 8033.8 Cross · (Hw 875 FU)

Mechanisms

Mécanismes

				
Motor (kW) motor Moteur	75	9,0	2 x 7,5	4 x 5,5
Geschwindigkeit speed Vitesse	0 – 1,6 t 0...185 m/min stufenlos/ stepless/ en continue 0 – 8,5 t 0...44 m/min	0 – 3,0 t 0...100 m/min stufenlos/ stepless/ en continue 0 – 8,5 t 0...65 m/min	0,80 min ⁻¹	30,0 m/min
Hakenweg (m) hook path course du crochet	460			

WOLFF 8033.8 Cross Kolli Liste - Colli List - Liste de colisage

Pos. Pos.	Stck. Pcs.	Beschreibung / Description / Description	Kolli / Colli / Colis	L (m) Length Longueur	B (m) Width Largeur	H (m) Height Hauteur	Gewicht (kg) Weight Poids	Volumen (m³) Volume Volume
1	1	Turmspitze kompl. / Tower top complete / Pointe de tour complète		11,55	2,30	2,50	15000	66,41
				11,75	2,32	2,80	16300	76,34
				7,39	2,49	1,66	2925	30,55
				5,60	2,30	1,25	12075	32,20
		Pos. 1 zerlegt / Item 1 disassembled / Pos. 1 groupe		5,80	2,32	2,80	13370	37,68
2	1	Führerhaus mit Aufhängung / Driver's cabin with suspension / Cabine avec fixation		4,82	2,19	2,55	3030	26,92
3	1	Gegenausleger geklappt / Counterjib folded / Contre-flèche repliée		11,98	2,30	1,31	7140	36,10
				22,24	2,30	0,72	7140	36,83
4	1	Hw 875 FU Maschinenplattform / Machinery platform / Plateforme avec mécanisme de levage		2,17	1,88	1,18	2250	4,82
5	1	Auslegerteil 1 / Jib part 1 / Élément de flèche 1		10,19	1,64	2,29	3400	38,54
6	1	Auslegerteil 2 / Jib part 2 / Élément de flèche 2		10,19	1,64	2,08	2460	34,76
7	1	Auslegerteil 3 / Jib part 3 / Élément de flèche 3		10,23	1,64	2,08	2320	34,90
8	1	Auslegerteil 4 / Jib part 4 / Élément de flèche 4		10,30	1,64	2,07	2300	34,97
9	1	Auslegerteil 5 / Jib part 5 / Élément de flèche 5		5,33	1,64	2,03	1135	17,74
10	1	Auslegerteil 6 / Jib part 6 / Élément de flèche 6		2,83	1,64	2,03	695	9,42
11	1	Auslegerteil 7 / Jib part 7 / Élément de flèche 7		10,28	1,64	2,03	1815	34,22
12	1	Auslegerteil 8 / Jib part 8 / Élément de flèche 8		10,22	1,64	2,02	1290	33,86
13	1	Auslegerteil 9 / Jib part 9 / Élément de flèche 9		5,20	1,64	2,01	660	17,14
14	1	Auslegerteil 10 / Jib part 10 / Élément de flèche 10		10,19	1,64	2,01	1040	33,59
15	1	Seilwirbeltraverse / Rope swivel traverse / Traverse de pointe fixe		1,38	1,54	0,50	245	1,06
16	1	Laufkatze LK 8 / Trolley LK 8 / Chariot de distribution LK 8		1,87	1,85	1,00	330	3,46
17	1	Unterflasche U 8 / Hook block U 8 / Crochet U 8		1,02	0,26	1,70	505	0,45
18	1	Normgeländer / Standard handrail / Garde-corps		2,60	1,10	0,65	300	1,86
19	1	Kiste (Kleinteile) / Box (small parts) / Caisse à outils		0,63	0,50	0,38	100	1,12
20	1	Wartungskorb / Service cage / Nacelle de transport de personne		0,75	0,55	1,69	55	0,70

Technische und inhaltliche Änderungen sind vorbehalten. / All rights reserved regarding technical and content changes. / Sous réserve de modifications techniques et de fond.

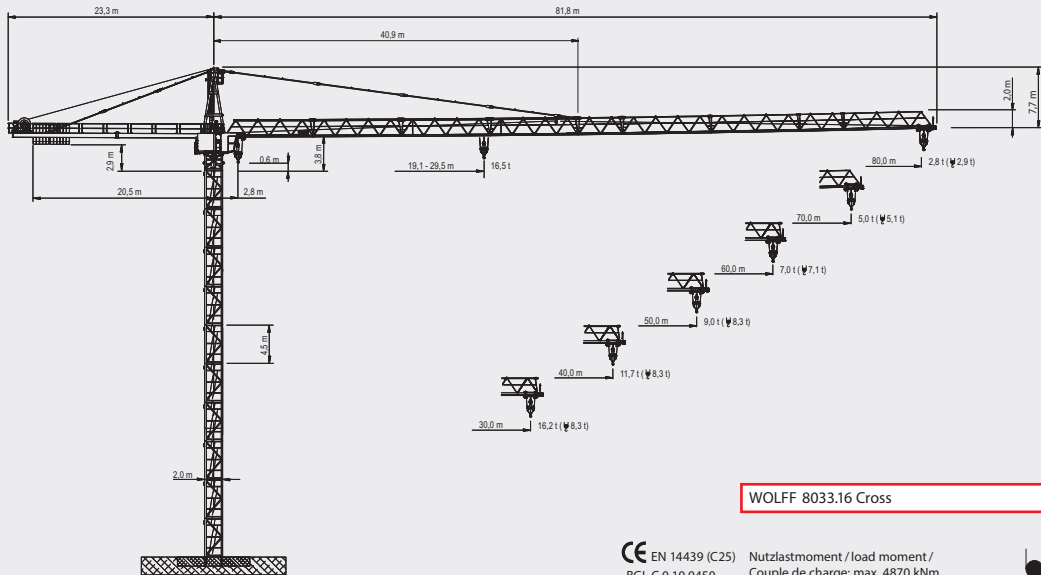

WOLFF 8033.16 Cross

CE EN 14439 (C25)
BGL C.0.10.0450

Nutzlastmoment / load moment /
Couple de charge: max. 4870 kNm
Traglast / lifting capacity /
Capacité de levage: max. 16,5 t
Ausladung / jib radius /
Portée: max. 80,0 m

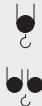

WOLFF 8033.16 Cross Turmkombinationen · Tower configurations · Combinaisons de tour

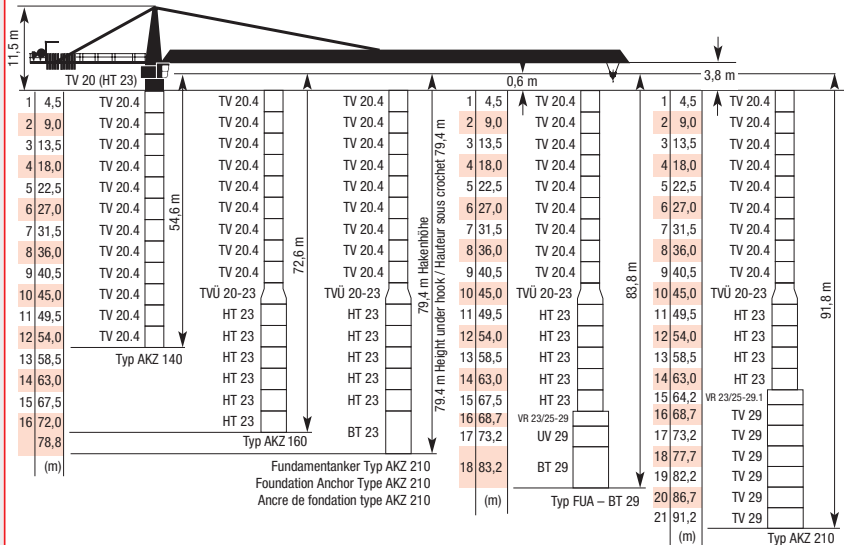

Weitere Standbasen auf Anfrage / Further base frames on request / Pour d'autres bases, nous consulter

Traglasten (t) · WOLFF 8033.16 Cross

Load Data

Charges

Ausladung (m) / jib radius (m) / Portée (m)		30	32,5	35	37,5	40	42,5	45	47,5	50	52,5	55	57,5	60	62,5	65	67,5	70	72,5	75	77,5	80	
Auslegerlänge (m) / jib length (m) / Longueur de flèche (m)	80,0	2,8 – 35,4	8,3	8,3	8,3	7,8	7,2	7,0	6,3	5,8	5,5	5,6	4,9	4,6	4,3	4,1	3,9	3,7	3,5	3,3	3,2	3,0	2,9
	77,5	2,8 – 39,1	8,3	8,3	8,3	8,3	8,1	7,5	7,0	6,6	6,2	5,8	5,5	5,2	4,9	4,7	4,4	4,2	4,0	3,8	3,7	3,5	
	75,0	2,8 – 42,5	8,3	8,3	8,3	8,3	8,3	8,3	7,8	7,3	6,9	6,5	6,1	5,8	5,5	5,2	4,9	4,7	4,5	4,3	4,1		
	72,5	2,8 – 44,8	8,3	8,3	8,3	8,3	8,3	8,3	7,8	7,3	6,9	6,5	6,2	5,9	5,6	5,3	5,0	4,8	4,6				
	70,0	2,8 – 46,9	8,3	8,3	8,3	8,3	8,3	8,3	8,2	7,7	7,3	6,9	6,5	6,2	5,9	5,6	5,3	5,0	4,8	4,6			
	67,5	2,8 – 48,7	8,3	8,3	8,3	8,3	8,3	8,3	8,3	8,3	8,1	7,6	7,2	6,8	6,5	6,2	5,9	5,6					
	65,0	2,8 – 50,2	8,3	8,3	8,3	8,3	8,3	8,3	8,3	8,3	8,3	7,9	7,5	7,1	6,7	6,4	6,1						
	62,5	2,8 – 51,5	8,3	8,3	8,3	8,3	8,3	8,3	8,3	8,3	8,3	8,1	7,7	7,3	6,9	6,6							
	60,0	2,8 – 52,6	8,3	8,3	8,3	8,3	8,3	8,3	8,3	8,3	8,3	8,3	7,9	7,5	7,1								
	57,5	2,8 – 53,4	8,3	8,3	8,3	8,3	8,3	8,3	8,3	8,3	8,3	8,3	8,0	7,6									
	55,0	2,8 – 53,9	8,3	8,3	8,3	8,3	8,3	8,3	8,3	8,3	8,3	8,3	8,1										
	52,5	2,8 – 52,5	8,3 t	8,3	8,3	8,3	8,3	8,3	8,3	8,3	8,3	8,3											
	50,0	2,8 – 50,0	8,3	8,3	8,3	8,3	8,3	8,3	8,3	8,3	8,3												
	47,5	2,8 – 47,5	8,3	8,3	8,3	8,3	8,3	8,3	8,3	8,3													
	45,0	2,8 – 45,0	8,3	8,3	8,3	8,3	8,3	8,3	8,3														
	42,5	2,8 – 42,5	8,3	8,3	8,3	8,3	8,3	8,3															
	40,0	2,8 – 40,0	8,3	8,3	8,3	8,3	8,3																
37,5	2,8 – 37,5	8,3	8,3	8,3	8,3																		
35,0	2,8 – 35,0	8,3	8,3	8,3																			
32,5	2,8 – 32,5	8,3	8,3																				
30,0	2,8 – 30,0	8,3																					

Tragfähigkeit (t) / load capacity (t) / Capacité de charge (t)

Traglasten (t) · WOLFF 8033.16 Cross

Load Data

Charges

Ausladung (m) / jib radius (m) / Portée (m)		30	32,5	35	37,5	40	42,5	45	47,5	50	52,5	55	57,5	60	62,5	65	67,5	70	72,5	75	77,5	80
Auslagerlänge (m) / jib length (m) / Longueur de flèche (m)	80,0 2,8 – 19,1	10,0	9,1	8,3	7,7	7,1	6,6	6,1	5,7	5,4	5,1	4,8	4,5	4,2	4,0	3,8	3,6	3,4	3,2	3,1	2,9	2,8
	77,5 2,8 – 21,1	11,1	10,2	9,3	8,6	8,0	7,4	6,9	6,5	6,1	5,7	5,4	5,1	4,8	4,6	4,3	4,1	3,9	3,7	3,6	3,4	
	75,0 2,8 – 22,9	12,2	11,2	10,3	9,5	8,8	8,2	7,7	7,2	6,8	6,4	6,0	5,7	5,4	5,1	4,8	4,6	4,4	4,2	4,0		
	72,5 2,8 – 24,1	13,0	11,9	10,9	10,1	9,4	8,7	8,2	7,7	7,2	6,8	6,4	6,1	5,8	5,5	5,2	4,9	4,7	4,5			
	70,0 2,8 – 25,3	13,7	12,5	11,5	10,6	9,9	9,2	8,6	8,1	7,6	7,2	6,8	6,4	6,1	5,8	5,5	5,2	5,0				
	67,5 2,8 – 26,2	14,2	13,0	12,0	11,1	10,3	9,6	9,0	8,4	8,0	7,5	7,1	6,7	6,4	6,1	5,8	5,5					
	65,0 2,8 – 27,1	14,7	13,5	12,4	11,5	10,7	10,0	9,3	8,8	8,3	7,8	7,4	7,0	6,6	6,3	6,0						
	62,5 2,8 – 27,8	15,2	13,9	12,8	11,8	11,0	10,3	9,6	9,0	8,5	8,0	7,6	7,2	6,8	6,5							
	60,0 2,8 – 28,3	15,5	14,2	13,1	12,1	11,3	10,5	9,8	9,2	8,7	8,2	7,8	7,4	7,0								
	57,5 2,8 – 28,7	15,7	14,4	13,3	12,3	11,4	10,7	10,0	9,4	8,9	8,4	7,9	7,5									
	55,0 2,8 – 29,0	15,9	14,6	13,4	12,4	11,6	10,8	10,1	9,5	9,0	8,5	8,0										
	52,5 2,8 – 29,2	16,0	14,7	13,5	12,5	11,6	10,9	10,2	9,6	9,0	8,5											
	50,0 2,8 – 29,2	16,0	14,7	13,5	12,5	11,6	10,9	10,2	9,6	9,0												
	47,5 2,8 – 29,3	16,1	14,7	13,6	12,6	11,7	10,9	10,2	9,6													
	45,0 2,8 – 29,3	16,1	14,7	13,5	12,5	11,7	10,9	10,2														
	42,5 2,8 – 29,3	16,1	14,7	13,6	12,6	11,7	10,9															
	40,0 2,8 – 29,3	16,1	14,7	13,6	12,6	11,7																
	37,5 2,8 – 29,4	16,1	14,8	13,6	12,6																	
	35,0 2,8 – 29,4	16,1	14,8	13,6																		
	32,5 2,8 – 29,4	16,2	14,8																			
30,0 2,8 – 29,5	16,2																					







16,5 t

Tragfähigkeit (t) / load capacity (t) / Capacité de charge (t)























Antriebe · WOLFF 8033.16 Cross · (Hw 875 FU)

Mechanisms

Mécanismes

					
Motor (kW) motor Moteur	75	75	9,0	2 x 7,5	4 x 5,5
Geschwindigkeit speed Vitesse	0 – 1,3 t 0...185 m/min stufenlos/ stepless/ en continue 0 – 8,3 t 0...44 m/min	0 – 3,4 t 0...94 m/min stufenlos/ stepless/ en continue 0 – 16,5 t 0...23 m/min	0 – 3,0 t 0...100 m/min stufenlos/ stepless/ en continue 0 – 8,3 t 0...65 m/min 0 – 16,5 t 0...32 m/min	0,8 min ⁻¹	30,0 m/min
Hakenweg (m) hook path course du crochet	460	230			

WOLFF 8033.16 Cross Kolliliste - Colli List - Liste de colisage

Pos. Pos. Pos.	Stck. Pce. Pcs.	Beschreibung / Description / Description	Kollil / Colli / Colis	L (m) Length Longueur	B (m) Width Largeur	H (m) Height Hauteur	Gewicht (kg) Weight Poids	Volumen (m³) Volume Volume
1	1	Turmspitze kompl. / Tower top complete / Pointe de tour complète		11,55	2,30	2,50	15000	66,41
		Turmspitzenoberenteil / Tower top upper part / Porte-flèche		11,75	2,32	2,80	16300	76,34
		Pos. 1 zerlegt / Item 1 disassembled / Pos. 1 groupe		7,39	2,49	1,66	2925	30,55
		Turmspitzenunterteil / Tower top lower part / Pivot tournant		5,60	2,30	2,50	12075	32,20
		Pos. 1 zerlegt / Item 1 disassembled / Pos. 1 groupe		5,80	2,32	2,80	13370	37,68
2	1	Führerhaus mit Aufhängung / Driver's cabin with suspension / Cabine avec fixation		4,82	2,19	2,55	3030	26,92
3	1	Gegenausleger geklappt / Counterjib folded / Contre-flèche repliée		11,98	2,30	1,31	7140	36,10
		Gegenausleger / Counterjib / Contre-flèche		22,24	2,30	0,72	7140	36,83
4	1	Hw 875 FU Maschinenplattform / Machinery platform / Plateforme avec mécanisme de flèche		2,17	1,88	1,18	2250	4,82
5	1	Auslegerteil 1 / Jib part 1 / Élément de flèche 1		10,19	1,64	2,29	3400	38,54
6	1	Auslegerteil 2 / Jib part 2 / Élément de flèche 2		10,19	1,64	2,08	2460	34,76
7	1	Auslegerteil 3 / Jib part 3 / Élément de flèche 3		10,23	1,64	2,08	2320	34,90
8	1	Auslegerteil 4 / Jib part 4 / Élément de flèche 4		10,30	1,64	2,07	2300	34,97
9	1	Auslegerteil 5 / Jib part 5 / Élément de flèche 5		5,33	1,64	2,03	1135	17,74
10	1	Auslegerteil 6 / Jib part 6 / Élément de flèche 6		2,83	1,64	2,03	695	9,42
11	1	Auslegerteil 7 / Jib part 7 / Élément de flèche 7		10,28	1,64	2,03	1815	34,22
12	1	Auslegerteil 8 / Jib part 8 / Élément de flèche 8		10,22	1,64	2,02	1290	33,86
13	1	Auslegerteil 9 / Jib part 9 / Élément de flèche 9		5,20	1,64	2,01	660	17,14
14	1	Auslegerteil 10 / Jib part 10 / Élément de flèche 10		10,19	1,64	2,01	1040	33,59
15	1	Seilwirbeltraverse / Rope swivel traverse / Traverse de pointe fixe		1,38	1,54	0,50	245	1,06
16	1	Laufkatze LK 8/16 / Trolley LK 8/16 / Chariot de distribution LK 8/16		1,87	1,85	1,00	455	3,46
17	1	Unterflasche U 8/16 / Hook block U 8/16 / Crochet U 8/16		1,02	0,26	1,70	780	0,45
18	1	Normgeländer / Standard handrail / Garde-corps		2,60	1,10	0,65	300	1,86
19	1	Kiste (Kleinteile) / Box (small parts) / Caisse à outils		0,63	0,50	0,38	100	1,12
20	1	Wartungskorb / Service cage / Nacelle de transport de personne		0,75	0,55	1,69	55	0,70

Technische und inhaltliche Änderungen sind vorbehalten. / All rights reserved regarding technical and content changes. / Sous réserve de modifications techniques et de fond.

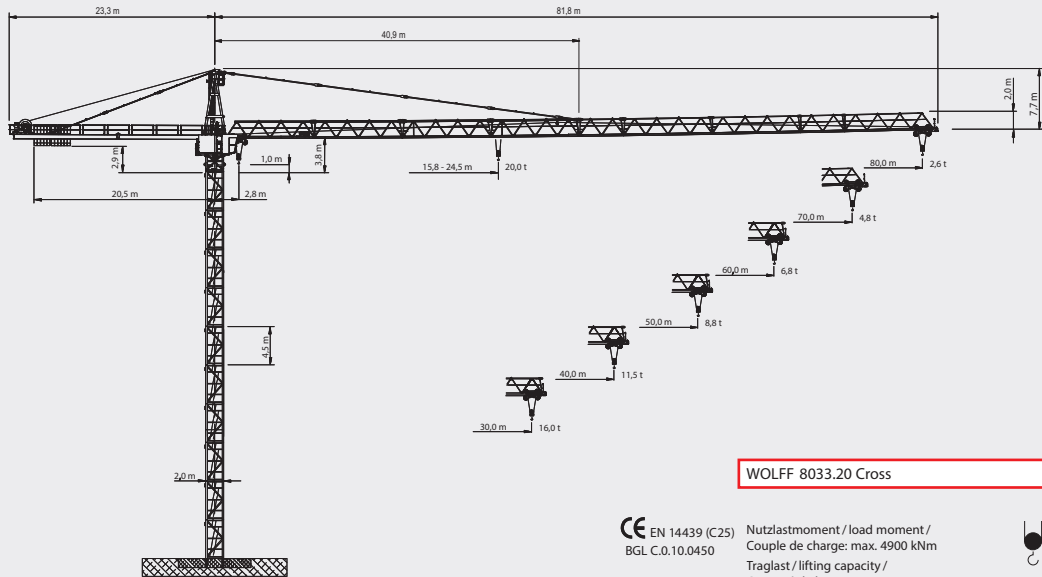

WOLFF 8033.20 Cross

CE EN 14439 (C25) Nutzlastmoment / load moment /
 BGL C.0.10.0450 Couple de charge: max. 4900 kNm
 Traglast / lifting capacity /
 Capacité de levage: max. 20,0 t
 Ausladung / jib radius /
 Portée: max. 80,0 m



WOLFF 8033.20 Cross Turmkombinationen - Tower configurations - Combinaisons de tour

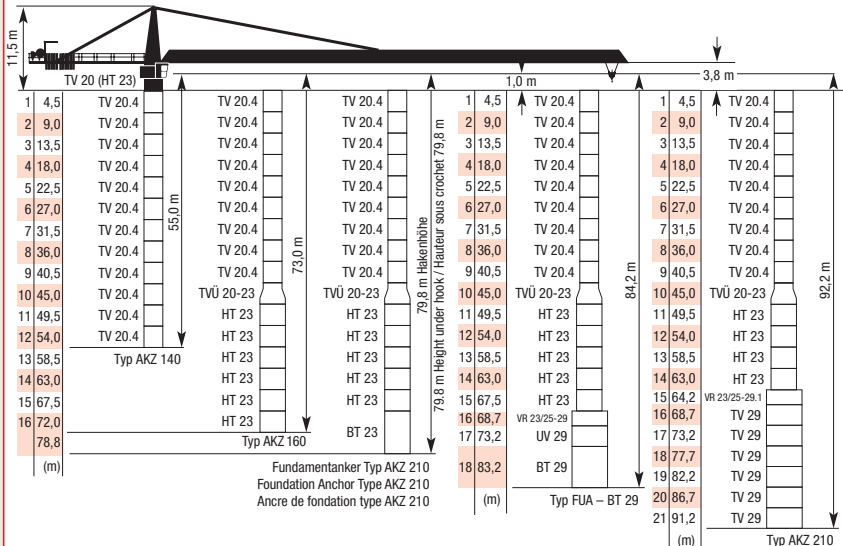

Weitere Standbasen auf Anfrage / Further base frames on request / Pour d'autres bases, nous consulter

Traglasten (t) · WOLFF 8033.20 Cross

Load Data

Charges

Ausladung (m) / jib radius (m) / Portée (m)		30	32,5	35	37,5	40	42,5	45	47,5	50	52,5	55	57,5	60	62,5	65	67,5	70	72,5	75	77,5	80	
80,0	2,8 – 15,8	9,8	8,9	8,1	7,5	6,9	6,4	5,9	5,5	5,2	4,9	4,6	4,3	4,0	3,8	3,6	3,4	3,2	3,0	2,9	2,7	2,6	
77,5	2,8 – 17,5	10,9	10,0	9,1	8,4	7,8	7,2	6,7	6,3	5,9	5,5	5,2	4,9	4,6	4,4	4,1	3,9	3,7	3,5	3,4	3,2		
75,0	2,8 – 19,0	12,0	10,1	10,1	9,3	8,6	8,0	7,5	7,0	6,6	6,2	5,8	5,5	5,2	4,9	4,6	4,4	4,2	4,0	3,8			
72,5	2,8 – 20,0	12,8	11,7	10,7	9,9	9,2	8,5	8,0	7,5	7,0	6,6	6,2	5,9	5,6	5,3	5,0	4,7	4,5	4,3				
70,0	2,8 – 21,0	13,5	12,3	11,3	10,4	9,7	9,0	8,4	7,9	7,4	7,0	6,6	6,2	5,9	5,6	5,3	5,0	4,8					
67,5	2,8 – 21,8	14,0	12,8	11,8	10,9	10,1	9,4	8,8	8,2	7,8	7,3	6,9	6,5	6,2	5,9	5,6	5,3						
65,0	2,8 – 22,5	14,5	13,3	12,2	11,3	10,5	9,8	9,1	8,6	8,1	7,6	7,2	6,8	6,4	6,1	5,8							
62,5	2,8 – 23,0	15,0	13,7	12,6	11,6	10,8	10,1	9,4	8,8	8,3	7,8	7,4	7,0	6,6	6,3								
60,0	2,8 – 23,5	15,3	14,0	12,9	11,9	11,1	10,3	9,6	9,0	8,5	8,0	7,6	7,2	6,8									
57,5	2,8 – 23,8	15,5	14,2	13,1	12,1	11,2	10,5	9,8	9,2	8,7	8,2	7,7	7,3										
55,0	2,8 – 24,1	15,7	14,4	13,2	12,2	11,4	10,6	9,9	9,3	8,8	8,3	7,8											
52,5	2,8 – 24,2	15,8	14,5	13,3	12,3	11,4	10,7	10,0	9,4	8,8	8,3												
50,0	2,8 – 24,2	15,8	14,5	13,3	12,3	11,4	10,7	10,0	9,4	8,8													
47,5	2,8 – 24,3	15,9	14,5	13,4	12,4	11,5	10,7	10,0	9,4														
45,0	2,8 – 24,3	15,9	14,5	13,3	12,3	11,5	10,7	10,0															
42,5	2,8 – 24,3	15,9	14,5	13,4	12,4	11,5	10,7																
40,0	2,8 – 24,3	15,9	14,5	13,4	12,4	11,5																	
37,5	2,8 – 24,4	15,9	14,6	13,4	12,4																		
35,0	2,8 – 24,4	15,9	14,6	13,4																			
32,5	2,8 – 24,4	16,0	14,6																				
30,0	2,8 – 24,5	16,0																					

Auslegerlänge (m) / jib length (m) / Longueur de flèche (m)







20,0 t

Tragfähigkeit (t) / load capacity (t) / Capacité de charge (t)

Antriebe · WOLFF 8033.20 Cross · (Hw 2075 FU)

Mechanisms



Mécanismes

				
Motor (kW) motor Moteur	75	9,0	2 x 7,5	4 x 5,5
Geschwindigkeit speed Vitesse	0 – 2,1 t 0...132 m/min stufenlos/ stepless/ en continue 0 – 20,0 t 0...19 m/min	0 – 3,3 t 0...100 m/min stufenlos/ stepless/ en continue 0 – 20,0 t 0...32 m/min	0,8 min ⁻¹	30,0 m/min
Hakenweg (m) hook path course du crochet	400			

Antriebe · WOLFF 8033.20 Cross · (Hw 20110 FU)

Mechanisms

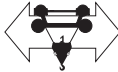
Mécanismes

				
Motor (kW) motor Moteur	110	9,0	2 x 7,5	4 x 5,5
Geschwindigkeit speed Vitesse	0 – 2,2 t 0...190 m/min stufenlos/ stepless/ en continue 0 – 20,0 t 0...28 m/min	0 – 3,3 t 0...100 m/min stufenlos/ stepless/ en continue 0 – 20,0 t 0...32 m/min	0,8 min ⁻¹	30,0 m/min
Hakenweg (m) hook path course du crochet	400			

WOLFF 8033.20 Cross Kollli Liste - Colli List - Liste de colisage								
Pos. Pos. Pos.	Stck. Pce. Pcs.	Beschreibung / Description / Description	Kollli / Colli / Colis	L (m) Length Longueur	B (m) Width Largeur	H (m) Height Hauteur	Gewicht (kg) Weight Poids	Volumen (m³) Volume Volume
1	1	Turmspitze kompl. / Tower top complete / Pointe de tour complète		11,55	2,30	2,50	15000	66,41
		Turmspitzenoberteil / Tower top upper part / Porte-flèche		11,75	2,32	2,80	16300	76,34
		Turmspitzenunterteil / Tower top lower part / Pivot tournant		7,39	2,49	1,66	2925	30,55
		Pos. 1 zerlegt / Item 1 disassembled / Pos. 1 groupé		5,80	2,30	2,50	12075	32,20
		Pos. 1 zerlegt / Item 1 disassembled / Pos. 1 groupé		5,80	2,32	2,80	13770	37,68
2	1	Führerhaus mit Aufhängung / Driver's cabin with suspension / Cabine avec fixation		4,82	2,19	2,55	3030	26,92
3	1	Gegenausleger geklappt / Counterjib folded / Contre-flèche repliée Gegenausleger / Counterjib / Contre-flèche		11,98	2,30	1,31	7140	36,10
				22,24	2,30	0,72	7140	36,83
4	1	Hw 20110 FU Maschinenplattform / Machinery platform / Plateforme avec mécanisme de levage Hw 2075 FU Maschinenplattform / Machinery platform / Plateforme avec mécanisme de levage		2,58	2,31	1,70	4930	10,13
				2,58	2,31	1,70	4880	10,13
5	1	Auslegerteil 1 / Jib part 1 / Élément de flèche 1		10,19	1,64	2,29	3400	38,54
6	1	Auslegerteil 2 / Jib part 2 / Élément de flèche 2		10,19	1,64	2,08	2460	34,76
7	1	Auslegerteil 3 / Jib part 3 / Élément de flèche 3		10,23	1,64	2,08	2320	34,90
8	1	Auslegerteil 4 / Jib part 4 / Élément de flèche 4		10,30	1,64	2,07	2300	34,97
9	1	Auslegerteil 5 / Jib part 5 / Élément de flèche 5		5,33	1,64	2,03	1135	17,74
10	1	Auslegerteil 6 / Jib part 6 / Élément de flèche 6		2,83	1,64	2,03	695	9,42
11	1	Auslegerteil 7 / Jib part 7 / Élément de flèche 7		10,28	1,64	2,03	1815	34,22
12	1	Auslegerteil 8 / Jib part 8 / Élément de flèche 8		10,22	1,64	2,02	1290	33,86
13	1	Auslegerteil 9 / Jib part 9 / Élément de flèche 9		5,20	1,64	2,01	660	17,14
14	1	Auslegerteil 10 / Jib part 10 / Élément de flèche 10		10,19	1,64	2,01	1040	33,59
15	1	Seilwirbeltraverse / Rope swivel traverse / Traverse de pointe fixe		1,38	1,54	0,50	245	1,06
16	1	Laufkatze LK 20 / Trolley LK 20 / Chariot de distribution LK 20		2,00	1,88	1,33	600	5,00
17	1	Unterflasche U 20 / Hook block U 20 / Crochet U 20		0,72	0,29	1,84	750	0,38
18	1	Normgeländer / Standard handrail / Garde-corps		2,60	1,10	0,65	300	1,86
19	1	Kiste (Kleinteile) / Box (small parts) / Caisse à outils		0,63	0,50	0,38	100	1,12
20	1	Wartungskorb / Service cage / Nacelle de transport de personne		0,75	0,55	1,69	55	0,70

Technische und inhaltliche Änderungen sind vorbehalten. / All rights reserved regarding technical and content changes. / Sous réserve de modifications techniques et de fond.

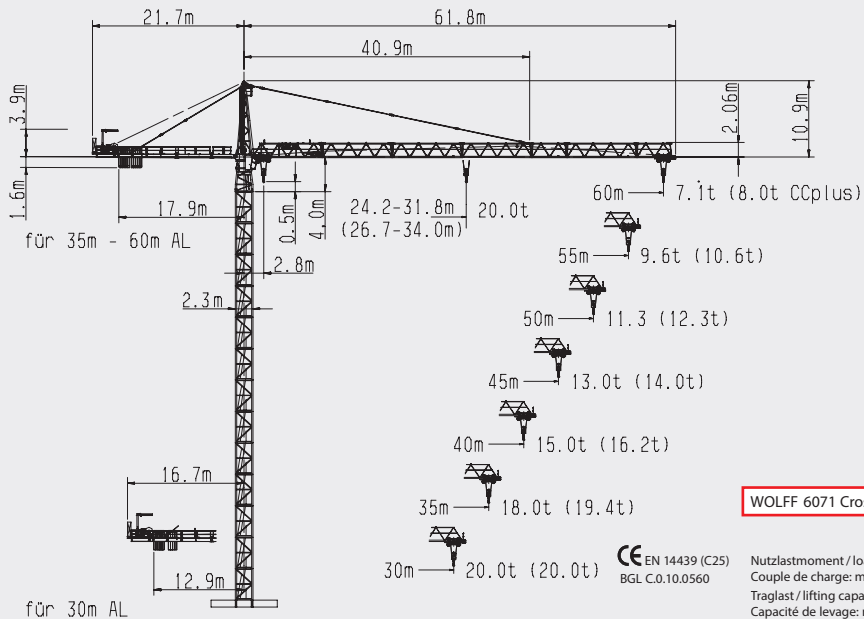

WOLFF 6071 Cross

CE EN 14439 (C25)
BGL C.0.10.0560

Nutzlastmoment / load moment /
Couple de charge: max. 6360 kNm
Traglast / lifting capacity /
Capacité de levage: max. 20,0 t
Ausladung / jib radius /
Portée: max. 60,0 m



WOLFF 6071 Cross Turmkombinationen · Tower configurations · Combinaisons de tour

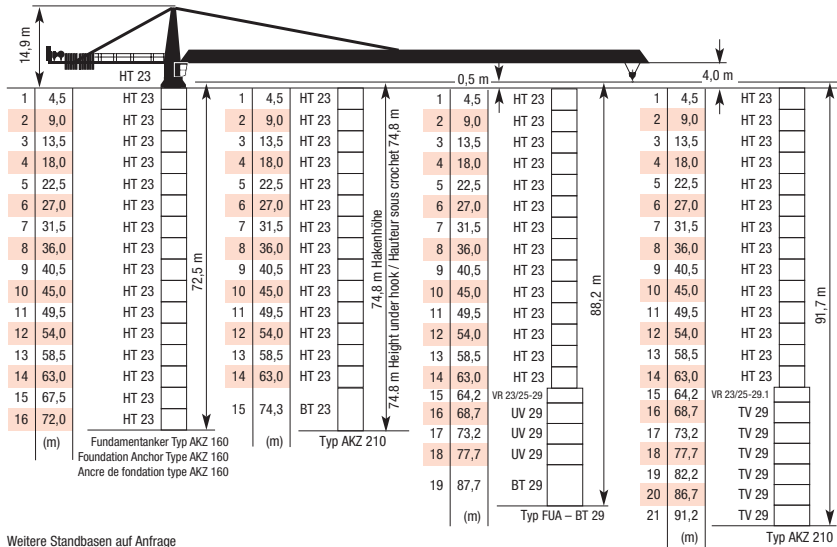

Weitere Standbasen auf Anfrage
 Further base frames on request
 Pour d'autres bases, nous consulter

Traglasten (t) · WOLFF 6071 Cross

Load Data

Charges





Ausladung (m) / jib radius (m) / Portée (m)			25	30	35	40	45	50	55	60		
Auslegerlänge (m) jib length (m) Longueur de flèche (m)	60	2,8 – 24,2	 20,0 t	19,3	15,8	13,3	11,5	10,0	8,8	7,9	7,1	Tragfähigkeit (t) load capacity (t) Capacité de charge (t)
	55	2,8 – 28,5		20,0	18,9	16,0	13,8	12,1	10,7	9,6	(8,0)	
	50	2,8 – 29,9		20,0	19,9	16,8	14,5	12,7	11,3	(10,6)		
	45	2,8 – 30,4		20,0	20,0	17,2	14,8	13,0	(12,3)			
	40	2,8 – 30,7		20,0	20,0	17,4	15,0	(14,0)				
	35	2,8 – 31,8		20,0	20,0	18,0	(16,2)					
	30	2,8 – 30,0		20,0	20,0	(19,4)						

- () CC plus Traglasten bei verringerten Arbeitsgeschwindigkeiten
 CC plus loads capacity with reduced operating speeds
 CC plus charges avec vitesses de travail réduites











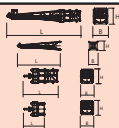



Antriebe · WOLFF 6071 Cross · (Hw 2075 FU)

Mechanisms

Mécanismes

				
Motor (kW) motor Moteur	75	9,0	2 x 7,5	6 x 5,5
Geschwindigkeit speed Vitesse	0 – 1,8 t 0...125 m/min stufenlos/ stepless/ en continue 0 – 20,0 t 0...18 m/min	0 – 4,0 t 0...92 m/min stufenlos/ stepless/ en continue 0 – 20,0 t 0...34 m/min	0,75 min ⁻¹	25,0 m/min
Hakenweg (m) hook path course du crochet	400			

WOLFF 6071 Cross Kollif Liste - Colli List - Liste de colisage

Pos. Pos. Pos.	Stck. Pce. Pcs.	Beschreibung / Description / Description	Kollif / Colli / Colis	L (m) Length Longueur	B (m) Width Largeur	H (m) Height Hauteur	Gewicht (kg) Weight Poids	Volumen (m³) Volume Volume
1	1	Turmspitze kompl. / Tower top complete / Pointe de tour complète Turmspitzenoberteil / Tower top upper part / Porte-flèche <small>Pos. 1 zerlegt / Item 1 disassembled / Pos. 1 groupe</small> Turmspitzenunterteil kompl. / Tower top lower part complete / Pivot tournant complète <small>Pos. 1 zerlegt / Item 1 disassembled / Pos. 1 groupe</small> Turmspitzenunterteil / Tower top lower part / Pivot tournant <small>Pos. 1 zerlegt / Item 1 disassembled / Pos. 1 groupe</small>		14,87	2,99	2,80	19410	124,49
				10,52	2,10	2,20	4280	48,60
				5,80	2,32	2,80	13835	37,68
				3,50	2,30	2,50	9730	20,10
2	1	Führerhaus mit Aufhängung / Driver's cabin with suspension / Cabine avec fixation		4,21	2,39	2,44	1800	24,55
3	1	Gegenausleger geklappt / Counterjib folded / Contre-flèche repliée Gegenausleger / Counterjib / Contre-flèche		11,60	2,10	1,50	6250	36,50
				20,12	2,10	0,75	6250	31,70
4	1	Hw 2075 FU Maschinenplattform / Machinery platform / Plateforme avec mécanisme de levage		2,30	3,73	2,30	6950	19,70
5	1	Auslegerteil 1 / Jib part 1 / Élément de flèche 1		10,22	2,06	2,40	3850	50,53
6	1(2x)	Auslegerteil 2 / Jib part 2 / Élément de flèche 2		10,25	2,06	2,18	2690	46,03
7	1	Auslegerteil 3 / Jib part 3 / Élément de flèche 3		10,29	2,06	2,17	2450	46,00
8	1	Auslegerteil 4 / Jib part 4 / Élément de flèche 4		5,31	2,06	2,13	1170	23,30
9	1	Auslegerteil 5 / Jib part 5 / Élément de flèche 5		10,27	2,06	2,12	1770	44,85
10	1	Auslegerteil 6 / Jib part 6 / Élément de flèche 6		5,23	2,06	2,15	830	45,20
11	1	Seilwirbeltraverse / Rope swivel traverse / Traverse de pointe fixe		1,53	1,98	0,50	280	1,50
12	1	Laufkatze LK 20 / Trolley LK 20 / Chariot de distribution LK 20		2,00	2,23	1,30	740	5,80
13	1	Unterflasche U 20 / Hook block U 20 / Crochet U 20		1,30	0,60	1,30	630	1,00
14	1	Normgeländer / Standard handrail / Garde-corps		2,55	1,10	1,80	460	5,05
15	1	Kiste (Kleinteile) / Box (small parts) / Caisse à outils		1,60	0,90	0,80	500	1,15

Technische und inhaltliche Änderungen sind vorbehalten. / All rights reserved regarding technical and content changes. / Sous réserve de modifications techniques et de fond.

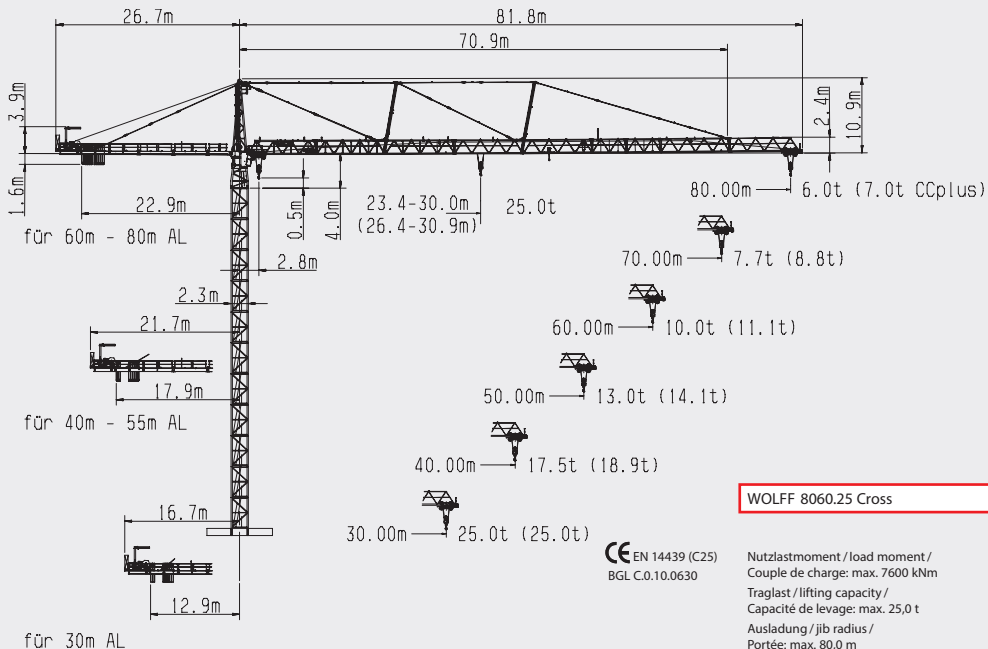

WOLFF 8060.25 Cross Turmkombinationen · Tower configurations · Combinaisons de tour

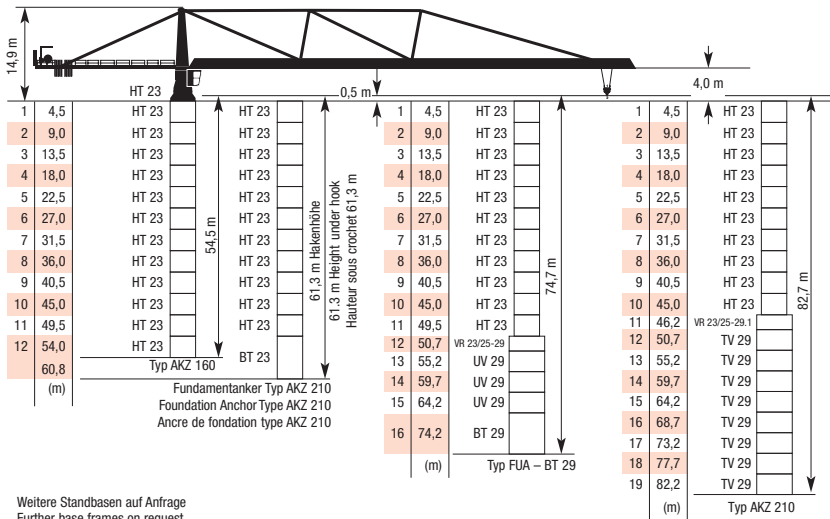

Traglasten (t) · WOLFF 8060.25 Cross

Load Data

Charges

Ausladung (m) / jib radius (m) / Portée (m)			30	35	40	45	50	55	60	65	70	75	80		
Auslegerlänge (m) jib length (m) Longueur de flèche (m)	80	2,8 – 23,4	 25,0 t	19,1	16,1	13,9	12,1	10,7	9,6	8,6	7,8	7,1	6,5	6,0	Tragfähigkeit (t) load capacity (t) Capacité de charge (t)
	75	2,8 – 24,2		19,8	16,7	14,4	12,6	11,3	9,9	9,0	8,1	7,4	6,8	(7,0)	
	70	2,8 – 24,9		20,4	17,3	14,9	13,0	11,5	10,3	9,3	8,4	7,7	(7,9)		
	65	2,8 – 25,8		21,2	17,9	15,5	13,5	12,0	10,7	9,7	8,8	(8,8)			
	60	2,8 – 26,5		21,9	18,5	15,9	14,0	12,4	11,1	10,0	(9,9)				
	55	2,8 – 26,9		22,3	18,8	16,2	14,2	12,6	11,3	(11,1)					
	50	2,8 – 27,6		22,9	19,4	16,7	14,7	13,0	(12,4)						
	45	2,8 – 28,2		23,4	19,8	17,1	15,0	(14,1)							
	40	2,8 – 28,8		24,0	20,3	17,5	(16,2)								
	30	2,8 – 30,0		25,0		(18,9)									

() CC plus Traglasten bei verringerten Arbeitsgeschwindigkeiten





CC plus loads capacity with reduced operating speeds

CC plus charges avec vitesses de travail réduites

Antriebe · WOLFF 8060.25 Cross · (Hw 25110 FU)

Mechanisms

Mécanismes

				
Motor (kW) motor Moteur	110	18,0	2 x 7,5	6 x 5,5
Geschwindigkeit speed Vitesse	0 – 2,8 t 0...159 m/min stufenlos/ stepless/ en continue 0 – 25,0 t 0...22 m/min	0 – 4,8 t 0...99 m/min stufenlos/ stepless/ en continue 0 – 25,0 t 0...57 m/min	0,75 min ⁻¹	25,0 m/min
Hakenweg (m) hook path course du crochet	400			

WOLFF 8060.25 Cross Kolli Liste - Colli List - Liste de colisage

Pos. Pos. Pos.	Stck. Pce. Pcs.	Beschreibung / Description / Description	Kolli / Colli / Colis	L (m) Length Longueur	B (m) Width Largeur	H (m) Height Hauteur	Gewicht (kg) Weight Poids	Volumen (m³) Volume Volume
1	1	Turmspitze kompl. / Tower top complete / Pointe de tour complète		14,87	2,99	2,80	19530	124,49
		Turmspitzenoberteil / Tower top upper part / Porte-flèche Pos. 1 zerlegt / Item 1 disassembled / Pos. 1 groupe		10,52	2,10	2,20	4280	48,60
		Turmspitzenunterteil kompl. / Tower top lower part complete / Pivot tournant complète Pos. 1 zerlegt / Item 1 disassembled / Pos. 1 groupe		5,80	2,32	2,80	13955	37,68
		Turmspitzenunterteil / Tower top lower part / Pivot tournant Pos. 1 zerlegt / Item 1 disassembled / Pos. 1 groupe		3,50	2,30	2,50	9730	20,10
2	1	Führerhaus mit Aufhängung / Driver's cabin with suspension / Cabine avec fixation		4,21	2,39	2,44	1800	24,55
3	1	Gegenausleger geklappt / Counterjib folded / Contre-flèche repliée		16,60	2,10	1,50	7700	52,30
		Gegenausleger / Counterjib / Contre-flèche		25,12	2,10	0,75	7700	39,60
4	1	Hw 25110 FU Maschinenplattform / Machinery platform / Plateforme avec mécanisme de levage		2,30	3,73	2,30	7290	19,70
5	1	Auslegerteil 1 / Jib part 1 / Élément de flèche 1		10,25	2,06	2,43	5160	51,30
6	1	Auslegerteil 2 / Jib part 2 / Élément de flèche 2		10,24	2,06	2,19	3460	46,20
7	1	Auslegerteil 3 / Jib part 3 / Élément de flèche 3		10,30	2,06	2,18	2630	46,30
8	1	Auslegerteil 4 / Jib part 4 / Élément de flèche 4		10,24	2,06	2,17	2240	45,80
9	1	Auslegerteil 5 / Jib part 5 / Élément de flèche 5		10,26	2,06	2,17	1970	45,90
10	2	Auslegerteil 6 / Jib part 6 / Élément de flèche 6		5,22	2,06	2,16	910	23,20
11	1	Auslegerteil 7 / Jib part 7 / Élément de flèche 7		10,22	2,06	2,16	1600	45,50
12	1	Auslegerteil 8 / Jib part 8 / Élément de flèche 8		10,22	2,06	2,13	1350	44,80
13	1	Auslegerteil 9 / Jib part 9 / Élément de flèche 9		5,21	2,06	2,16	840	23,20
14	1	Seilwirbeltraverse / Rope swivel traverse / Traverse de pointe fixe		1,55	1,98	0,50	310	1,50
15	1	Laufkatze LK 25 / Trolley LK 25 / Chariot de distribution LK 25		2,00	2,30	1,30	960	6,00
16	1	Unterflasche U 25 / Hook block U 25 / Crochet U 25		1,30	0,60	1,30	680	1,00
17	1	Normgeländer / Standard handrail / Garde-corps		2,55	1,10	1,80	460	5,05
18	1	Kiste (Kleinteile) / Box (small parts) / Caisse à outils		1,60	0,90	0,80	500	1,15

Technische und inhaltliche Änderungen sind vorbehalten. / All rights reserved regarding technical and content changes. / Sous réserve de modifications techniques et de fond.

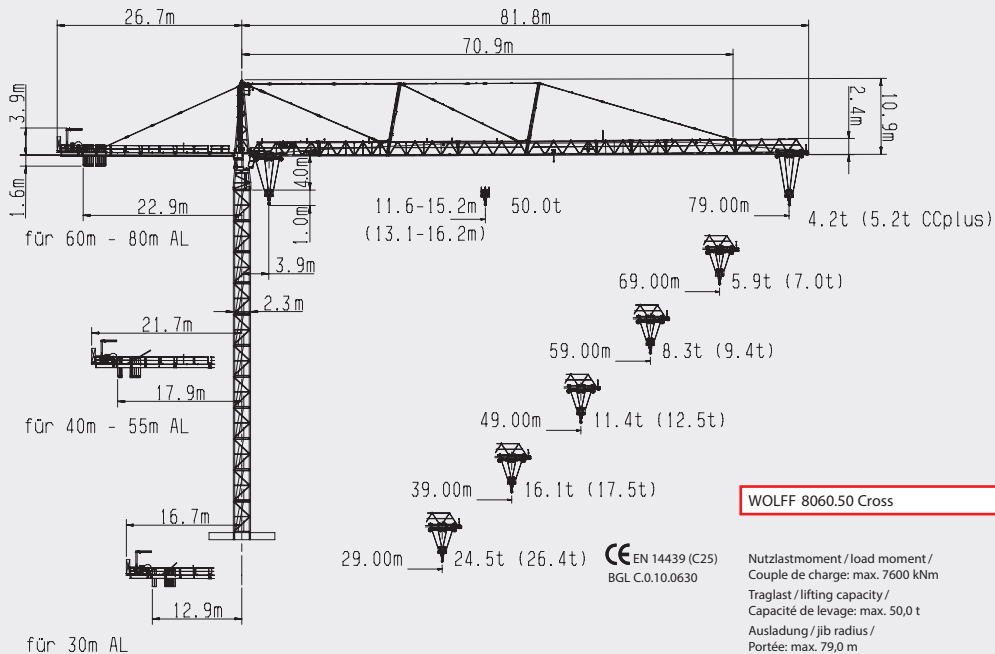

WOLFF 8060.50 Cross Turmkombinationen · Tower configurations · Combinaisons de tour

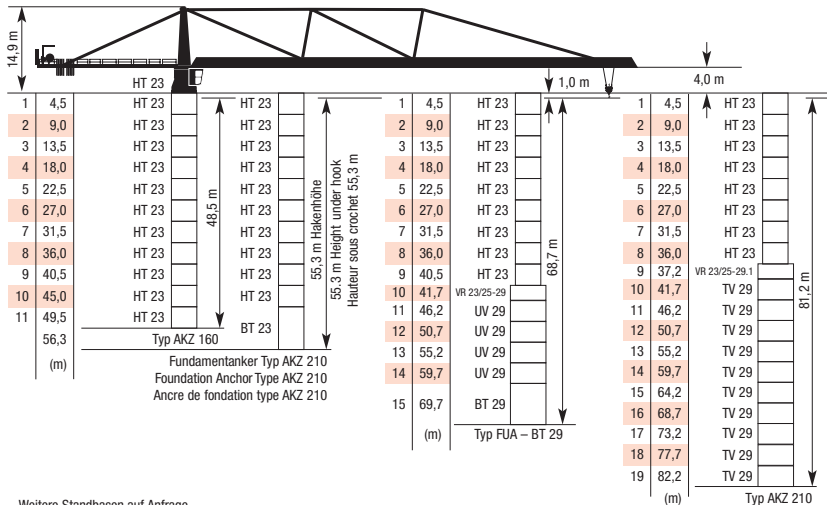

Weitere Standbasen auf Anfrage
 Further base frames on request
 Pour d'autres bases, nous consulter

Traglasten (t) · WOLFF 8060.50 Cross

Load Data

Charges

Ausladung (m) / jib radius (m) / Portée (m)			30	35	40	45	50	55	60	65	70	75	80		
Auslegerlänge (m) jib length (m) Longueur de flèche (m)	80	5,0 – 23,4	 25,0 t	19,1	16,1	13,9	12,1	10,7	9,6	8,6	7,8	7,1	6,5	6,0	Tragfähigkeit (t) load capacity (t) Capacité de charge (t)
	75	5,0 – 24,2		19,8	16,7	14,4	12,6	11,3	9,9	9,0	8,1	7,4	6,8	(7,0)	
	70	5,0 – 24,9		20,4	17,3	14,9	13,0	11,5	10,3	9,3	8,4	7,7	(7,9)		
	65	5,0 – 25,8		21,2	17,9	15,5	13,5	12,0	10,7	9,7	8,8	(8,8)			
	60	5,0 – 26,5		21,9	18,5	15,9	14,0	12,4	11,1	10,0	(9,9)				
	55	5,0 – 26,9		22,3	18,8	16,2	14,2	12,6	11,3	(11,1)					
	50	5,0 – 27,6		22,9	19,4	16,7	14,7	13,0	(12,4)						
	45	5,0 – 28,2		23,4	19,8	17,1	15,0	(14,1)							
	40	5,0 – 28,8		24,0	20,3	17,5	(16,2)								
	30	5,0 – 30,0		25,0		(18,9)									

() CC plus Traglasten bei verringerten Arbeitsgeschwindigkeiten

CC plus loads capacity with reduced operating speeds

CC plus charges avec vitesses de travail réduites

Traglasten (t) · WOLFF 8060.50 Cross

Load Data

Charges

Ausladung (m) / jib radius (m) / Portée (m)			30	35	40	45	50	55	60	65	70	75	80	
Auslegerlänge (m) jib length (m) Longueur de flèche (m)	80	3,9 – 11,6	17,1	14,1	11,9	10,2	8,8	7,6	6,7	5,9	5,2	4,6	4,2	Tragfähigkeit (t) load capacity (t) Capacité de charge (t)
	75	3,9 – 12,0	17,8	14,7	12,4	10,6	9,2	8,0	7,0	6,2	5,5	5,0	(5,2)	
	70	3,9 – 12,3	18,4	15,2	12,9	11,0	9,5	8,3	7,3	6,5	5,9	(6,1)		
	65	3,9 – 12,9	19,3	16,0	13,6	11,7	10,1	8,9	7,8	7,1	(7,0)			
	60	3,9 – 13,2	19,9	16,5	14,0	12,0	10,5	9,2	8,3	(8,2)				
	55	3,9 – 13,4	20,2	16,8	14,3	12,3	10,7	9,6	(9,4)					
	50	3,9 – 13,8	21,0	17,4	14,8	12,7	11,4	(10,7)						
	45	3,9 – 14,1	21,5	17,9	15,2	13,5	(12,5)							
	40	3,9 – 14,4	22,0	18,4	16,1	(14,7)								
	30	3,9 – 15,2	24,5		(17,5)									





- () CC plus Traglasten bei verringerten Arbeitsgeschwindigkeiten
 CC plus loads capacity with reduced operating speeds
 CC plus charges avec vitesses de travail réduites

Achtung! Im 4-fachen Seilstrangbetrieb verringert sich die maximale Ausladung jeweils um 1 m.
 Attention! With operation in 4 falls the maximum radii each are reduced about 1 meter.
 Attention ! La flèche maximale se réduit de 1 mètre en passant à l'opération à 4 brins de câble.











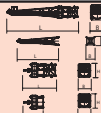

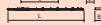



Antriebe · WOLFF 8060.50 Cross · (Hw 25110 FU)

Mechanisms

Mécanismes

					
Motor (kW) motor Moteur	110	110	18	2 x 7,5	6 x 5,5
Geschwindigkeit speed Vitesse	0 – 2,8 t 0...159 m/min stufenlos/ stepless/ en continue 0 – 25,0 t 0...22 m/min	0 – 5,6 t 0...79 m/min stufenlos/ stepless/ en continue 0 – 50,0 t 0...11 m/min	0 – 9,6 t 0...84 m/min stufenlos/ stepless/ en continue 0 – 50,0 t 0...26 m/min	0,75 min ⁻¹	25,0 m/min
Hakenweg (m) hook path course du crochet	400	200			

WOLFF 8060.50 Cross Kolliliste - Collilist - Liste de colisage

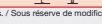
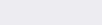
Pos. Pos. Pos.	Stk. Pce. Pcs.	Beschreibung / Description / Description	Kolliliste / Collilist / Liste de colisage	L (m) Length Longueur	B (m) Width Largeur	H (m) Height Hauteur	Gewicht (kg) Weight Poids	Volumen (m³) Volume Volume
1	1	Turmspitze kompl. / Tower top complete / Pointe de tour complète Turmspitzenoberteil / Tower top upper part / Porte-flèche Pos. 1 zerlegt / Item 1 disassembled / Pos. 1 groupe Turmspitzenunterteil kompl. / Tower top lower part complete / Pivot tournant complète Pos. 1 zerlegt / Item 1 disassembled / Pos. 1 groupe Turmspitzenunterteil / Tower top lower part / Pivot tournant Pos. 1 zerlegt / Item 1 disassembled / Pos. 1 groupe		14,87	2,99	2,80	19530	124,49
				10,52	2,10	2,20	4280	48,60
				5,80	2,32	2,80	13955	37,68
				3,50	2,30	2,50	9730	20,10
2	1	Führerhaus mit Aufhängung / Driver's cabin with suspension / Cabine avec fixation		4,21	2,39	2,44	1800	24,55
3	1	Gegenausleger geklappt / Counterjib folded / Contre-flèche repliée		16,60	2,10	1,50	7700	52,30
		Gegenausleger / Counterjib / Contre-flèche		25,12	2,10	0,75	7700	39,60
4	1	Hw 25110 FU Maschinenplattform / Machinery platform / Plateforme avec mécanisme de levage		2,30	3,73	2,30	7290	19,70
5	1	Auslegerteil 1 / Jib part 1 / Élément de flèche 1		10,25	2,06	2,43	5160	51,30
6	1	Auslegerteil 2 / Jib part 2 / Élément de flèche 2		10,24	2,06	2,19	3460	46,20
7	1	Auslegerteil 3 / Jib part 3 / Élément de flèche 3		10,30	2,06	2,18	2630	46,30
8	1	Auslegerteil 4 / Jib part 4 / Élément de flèche 4		10,24	2,06	2,17	2240	45,80
9	1	Auslegerteil 5 / Jib part 5 / Élément de flèche 5		10,26	2,06	2,17	1970	45,90
10	2	Auslegerteil 6 / Jib part 6 / Élément de flèche 6		5,22	2,06	2,16	910	23,20
11	1	Auslegerteil 7 / Jib part 7 / Élément de flèche 7		10,22	2,06	2,16	1600	45,50
12	1	Auslegerteil 8 / Jib part 8 / Élément de flèche 8		10,22	2,06	2,13	1350	44,80
13	1	Auslegerteil 9 / Jib part 9 / Élément de flèche 9		5,21	2,06	2,16	840	23,20
14	1	Seilwirbeltraverse / Rope swivel traverse / Traverse de pointe fixe		1,55	1,98	0,50	310	1,50
15	1	Laufkatze 2LK 25 / Trolley LK 2LK 25 / Chariot de distribution 2LK 25		2,32	2,30	1,30	940	6,90
16	1	Laufkatze 1LK 25 / Trolley 1LK 25 / Chariot de distribution 1LK 25		2,00	2,30	1,30	960	6,00
17	1	Unterflasche U 25/50 / Hook block U 25/50 / Crochet U 25/50		1,20	0,35	2,30	1320	1,00
18	1	Normgeländer / Standard handrail / Garde-corps		2,55	1,10	1,80	460	5,05
19	1	Kiste (Kleinteile) / Box (small parts) / Caisse à outils		1,60	0,90	0,80	500	1,15

Technische und inhaltliche Änderungen sind vorbehalten. / All rights reserved regarding technical and content changes. / Sous réserve de modifications techniques et de fond.

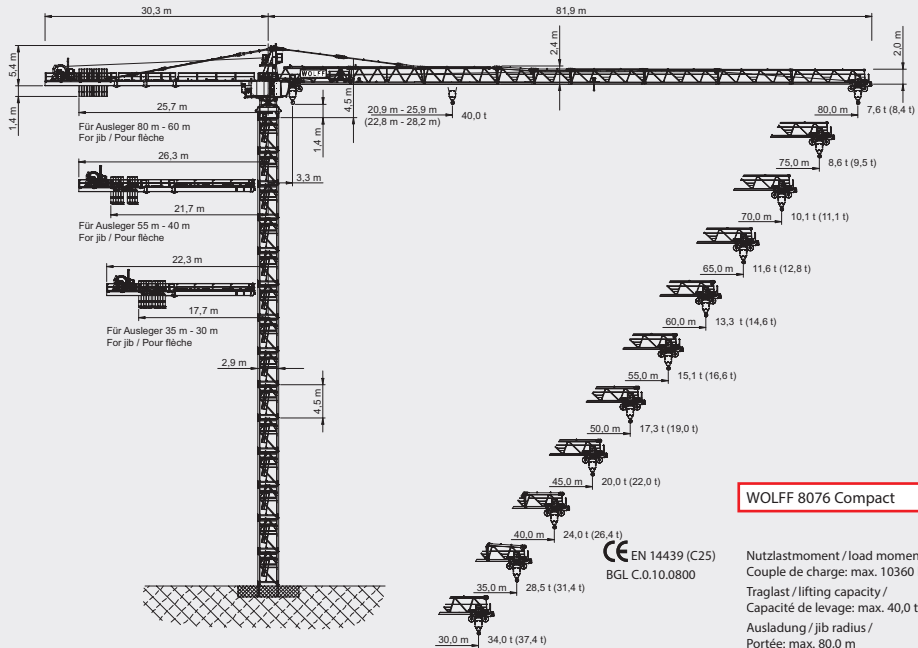

WOLFF 8076 Compact

CE EN 14439 (C25)
BGL C.0.10.0800

Nutzlastmoment / load moment /
Couple de charge: max. 10360 kNm
Traglast / lifting capacity /
Capacité de levage: max. 40,0 t
Ausladung / jib radius /
Portée: max. 80,0 m



WOLFF 8076 Compact Turmkombinationen - Tower configurations - Combinaisons de tour



in Vorbereitung / in preparation / en préparation

Traglasten (t) · WOLFF 8076 Compact

Load Data





Charges

Ausladung (m) / jib radius (m) / Portée (m)			20,0	25,0	30,0	35,0	40,0	45,0	50,0	55,0	60,0	65,0	70,0	75,0	80,0		
Auslegerlänge (m) / jib length (m) / Longueur de flèche (m)	80,0	3,3 - 20,9		40,0	32,9	26,8	22,4	19,1	16,5	14,5	12,8	11,4	10,3	9,2	8,4	7,6	Tragfähigkeit (t) / load capacity (t) / Capacité de charge (t)
	75,0	3,3 - 21,3		40,0	33,6	27,3	22,9	19,5	16,9	14,9	13,1	11,7	10,5	9,5	8,6		
	70,0	3,3 - 22,3		40,0	35,3	28,8	24,1	20,6	17,9	15,7	13,9	12,4	11,2	10,1			
	65,0	3,3 - 22,9		40,0	36,4	29,7	24,9	21,3	18,5	16,3	14,4	12,9	11,6				
	60,0	3,3 - 23,5		40,0	37,4	30,5	25,6	21,9	19,0	16,7	14,9	13,3					
	55,0	3,3 - 23,8		40,0	37,9	30,9	26,0	22,2	19,3	17,0	15,1						
	50,0	3,3 - 24,1		40,0	38,5	31,4	26,4	22,6	19,7	17,3							
	45,0	3,3 - 24,5		40,0	39,1	32,0	26,8	23,0	20,0								
	40,0	3,3 - 25,4		40,0	40,0	33,3	28,0	24,0									
	35,0	3,3 - 25,8		40,0	40,0	33,9	28,5										
	30,0	3,3 - 25,9		40,0	40,0	34,0											

Antriebe · WOLFF 8076 Compact · (Hw 40132 FU)

Mechanisms

Mécanismes

				
Motor (kW) motor Moteur	132	18,0	3 x 7,5	8 x 5,5
Geschwindigkeit speed Vitesse	0 – 5,4 t 0 ... 95 m/min stufenlos / stepless / en continue 0 – 40,0 t 0 ... 17 m/min	0 – 5,0 t 0...98 m/min stufenlos / stepless / en continue 0 – 40,0 t 0...26 m/min	0,70 min ⁻¹	30 ,0 m/min
Hakenweg (m) hook path course du crochet	400			

WOLFF 8076 Compact Kollifliste - Colli List - Liste de colisage - (Drehteil 80 m / Slewing part 80 m / Partie tournante 80 m)

Pos. Pos. Pos.	Stck. Pcs. Pcs.	Beschreibung / Description / Description	Kolli / Colli / Colis	L [m] Length Longueur	B [m] Width Largeur	H [m] Height Hauteur	Gewicht [kg] Weight Poids	Volumen [m³] Volume Volume
1	1	Turnspitze mit TV 29 Spul komplett / Tower head section with TV 29 connection complete / Tête de fût avec raccordement TV 29 complet		9,74	3,12	3,55	28230	107,88
	1	Turnspitzenoberenteil inkl. Abspannungen / Tower head section upper part incl. braces / Partie supérieure de la tête de fût incl. haubans		4,75	2,27	2,87	7860	30,95
	1	Turnspitzenunterteil mit TV 29 Spul / Tower head section lower part with TV 29 connection / Partie inférieure de la tête de fût avec raccordement TV 29		6,07	3,12	3,55	20370	67,23
2	1	Führerhausstation / Driver's cab with suspension / Cabine avec fixation		6,57	2,23	3,53	3755	51,72
3	1	Gegenauslegerstück 1 inkl. Abspannungen / Counterjib section 1 incl. braces / Section de contrefrèche 1 incl. haubans		11,74	2,30	2,00	11720	54,00
4	2	Gegenauslegerstück 2 / Counterjib section 2 / Section de contrefrèche 2		4,25	2,30	2,00	3210	19,55
5	1	Gegenauslegerstück 3 / Counterjib section 3 / Section de contrefrèche 3		9,81	2,30	2,00	7780	45,13
6	1	Hubwinde Hw 40132 FU inkl. 2. Bremse / Hoist winch Hw 40132 FU incl. 2nd brake / Treuil de levage Hw 40132 FU incl. 2e frein (Hubseil 220 m / Hoist rope 220 m / Câble de levage 220 m)		3,42	2,73	2,22	12435 (1150)	20,73
7	1	Ausbaukran mit Schwenkausleger / Auxiliary crane with hinged cantilever / Grue de démontage avec flèche pivotante		3,21	2,45	0,37	295	2,91
8	1	Hubseilunterstützung / Hoist rope support / L'assistance de câble de levage		1,81	1,51	1,75	210	4,78
9	1	Auslegerstück 1 mit WOLFF Schild / Jib element 1 with WOLFF sign / Élément de flèche 1 avec panneau WOLFF		10,39	2,01	2,79	9385	58,27
10	1	Auslegerstück 2 / Jib section 2 / Section de flèche 2		10,34	1,82	2,46	7495	46,29
11	1	Auslegerstück 3 / Jib section 3 / Section de flèche 3		10,51	1,82	2,48	7140	47,44
12	1	Auslegerstück 4 / Jib section 4 / Section de flèche 4		5,52	1,82	2,48	2775	24,92
13	1	Auslegerstück 5 / Jib section 5 / Section de flèche 5		5,51	1,82	2,17	2510	21,76
14	1	Auslegerstück 6 / Jib section 6 / Section de flèche 6		10,50	1,82	2,16	3825	41,38
15	1	Auslegerstück 7 / Jib section 7 / Section de flèche 7		10,47	1,82	2,13	3150	40,59
16	1	Auslegerstück 8 / Jib section 8 / Section de flèche 8		10,45	1,82	2,11	1985	40,13
17	1	Auslegerstück 9 / Jib section 9 / Section de flèche 9		10,38	1,82	2,08	1430	30,30
18	1	Wartungspodest Katzfahwerk / Maintenance podest trolley drive / Plateforme de maintenance du mécanisme de roulement du chariot		2,79	0,78	1,21	220	2,63
19	1	Auslegerabspannung / Jib brace / Hauban de flèche		8,32	2,63	0,43	6050	9,43
20	1	Selbstreibtraverse / Rope swivel crossbeam / Traverse à émerillon		1,22	1,85	1,65	425	3,72
21	1	Laufkatze LK 40 mit Wartungskorb / Trolley LK 40 with maintenance cage / Chariot LK 40 avec nacelle de maintenance		2,70	2,60	2,27	1960	15,94
22	1	Unterflasche U 40 / Hook block U 40 / Moufle à crochet U 40		1,89	0,90	0,40	1500	0,68
23	1	Wartungspodest Drehrahmen / Maintenance platform / Plateforme de maintenance châssis d'orientation		2,28	1,05	2,51	480	6,02
24	1	Podest Turnspitze / Platform tower head section / Plateforme de tête de fût		2,66	0,82	1,42	265	3,10
25	1	Gegengewicht 2,7 t / Counterweight 2,7 t / Contrepoids 2,7 t		2,28	1,41	0,36	2700	1,16
26	8	Gegengewicht 4,7 t / Counterweight 4,7 t / Contrepoids 4,7 t		3,85	1,41	0,36	4700	1,95



WOLFF

Turmkrane mit Wippausleger
tower cranes with luffing jib
grue à tour à flèche relevable

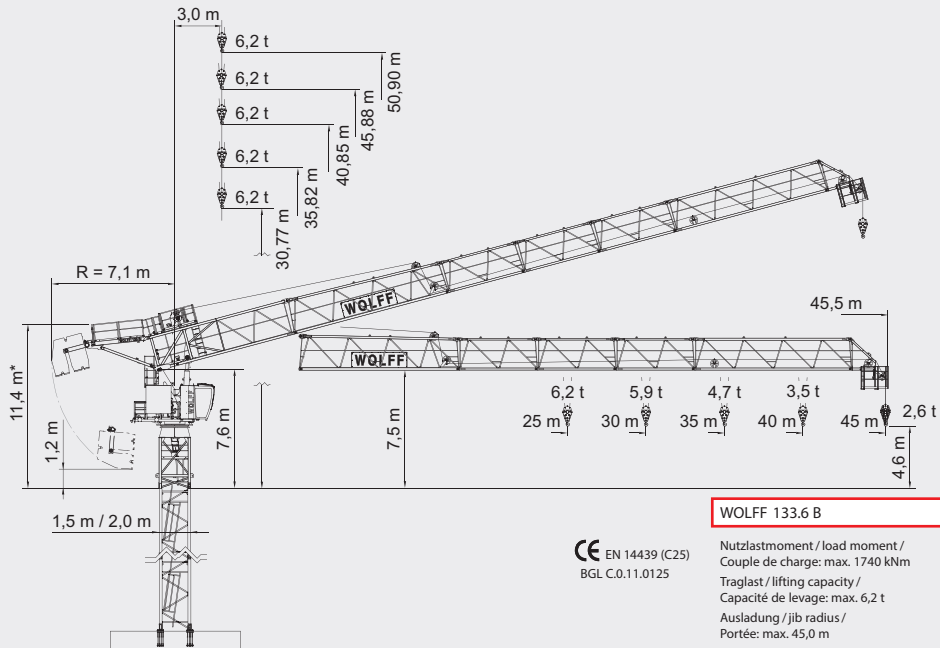

WOLFF 133 B Turmkombinationen · Tower configurations · Combinaisons de tour

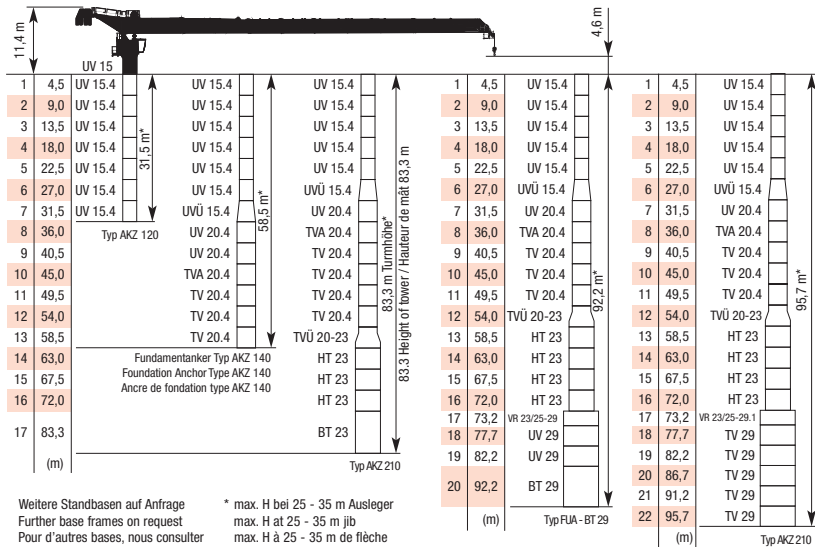

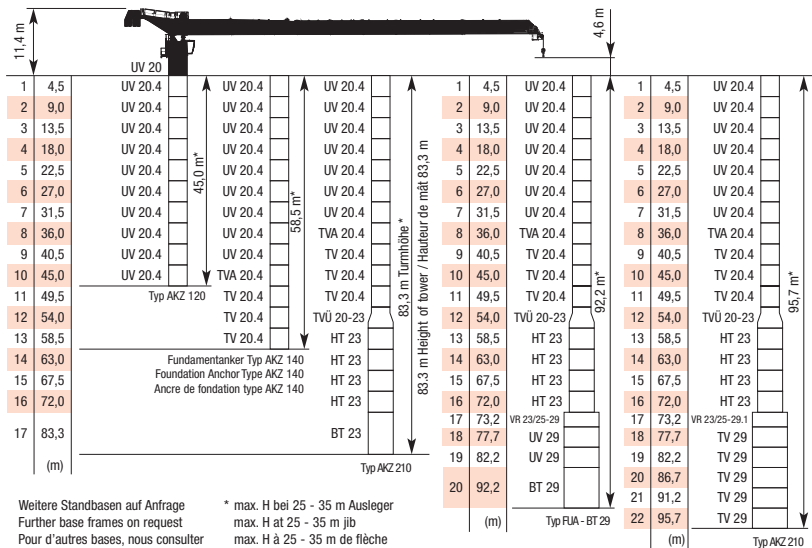

WOLFF 133 B Turmkombinationen · Tower configurations · Combinaisons de tour

Traglasten (t) · WOLFF 133.6 B

Load Data





Charges

Ausladung (m) / jib radius (m) / Portée (m)			20	25	30	35	40	45		
Auslegerlänge (m) jib length (m) Longueur de flèche (m)	45	3,0 - 39,4	 3,1 t	3,1	3,1	3,1	3,1	3,0	2,6	Tragfähigkeit (t) load capacity (t) Capacité de charge (t)
	40	3,0 - 40,0		3,1	3,1	3,1	3,1	3,1		
	35	3,0 - 35,0		3,1	3,1	3,1	3,1			
	30	3,0 - 30,0		3,1	3,1	3,1				
	25	3,0 - 25,0		3,1	3,1					
Ausladung (m) / jib radius (m) / Portée (m)			20	25	30	35	40	45		
Auslegerlänge (m) jib length (m) Longueur de flèche (m)	45	3,0 - 22,0	 6,2 t	6,2	5,3	4,3	3,5	2,9	2,5	Tragfähigkeit (t) load capacity (t) Capacité de charge (t)
	40	3,0 - 26,2		6,2	6,2	5,2	4,2	3,5		
	35	3,0 - 27,9		6,2	6,2	5,7	4,7			
	30	3,0 - 28,7		6,2	6,2	5,9				
	25	3,0 - 25,0		6,2	6,2					

















Antriebe · WOLFF 133.6 B · (Hw 628.1 FU)

Mechanisms

Mécanismes

					
Motor [kW] motor Moteur	28	28	22	1 x 7,5	4 x 5,5
Geschwindigkeit speed Vitesse	0 - 0,65 t 0 ... 160 m/min stufenlos / stepless / en continue 0 - 3,1 t 0 ... 44 m/min	0 - 1,0 t 0 ... 109 m/min stufenlos / stepless / en continue 0 - 6,2 t 0 ... 22 m/min	1,5 min	0,8 min ⁻¹	30,0 m/min
Hakenweg [m] hook path Course du crochet	400	200			

WOLFF 133.6 B Kolliliste - Colli List - Liste de colisage

Pos. Pos. Pos.	Stck. Pce. Pcs.	Beschreibung / Description / Description	Kolli / Colli / Colis	L [m] Length Longueur	B [m] Width Largeur	H [m] Height Hauteur	Gewicht [kg] Weight Poids	Volumen [m ³] Volume Volume
				UV 15 / TV 15				
				in Vorbereitung / in preparation / en préparation				
				UV 20				
1	1	Turmspitze komplett / Tower top complete / Pointe de tour complète		7,75	2,21	2,42	11410	41,45
	1	Verbindungsbock / Connection frame / Cadre de raccord <small>Pos. 1 zerlegt / Item 1 disassembled / Pos. 1 groupe mit Hydraulik / with hydraulic system / avec hydraulique</small>		3,28	1,58	2,52	5000	13,06
				UV 15 / TV 15				
				in Vorbereitung / in preparation / en préparation				
				UV 20				
1	1	Turmspitzenunterteil / Tower top lower part / Pivot tournant <small>Pos. 1 zerlegt / Item 1 disassembled / Pos. 1 groupe</small>		5,76	2,21	2,42	6410	30,81
2	1	Führerhaustation / Driver's cabin with suspension / Cabine avec fixation <small>inkl. Schaltschrank / incl. switch cabinet / avec armoire de distribution</small>		5,12	1,84	2,52	2415	23,74
3	1	Gegenausleger / Counterjib / Contre-flèche		6,15	2,38	0,73	2800	10,69
4	1	Hubwinde Hw 628.1 FU / Hoisting winch / Mécanisme de levage <small>mit Podest und Hubseil / with platform and hoisting rope / avec plateforme et câble de levage Ø 12 mm x 240 m = 175 kg</small>		3,14	2,30	0,94	2220	6,79
5	1	Auslegerstück 1 / Jib element 1 / Élément de flèche 1		9,44	1,63	2,54	4830	39,08
6	1	Auslegerstück 2 / Jib element 2 / Élément de flèche 2 <small>mit WOLFF Schild / with WOLFF sign / avec panneau WOLFF</small>		10,23	1,51	2,45	1945	37,85
7	1	Auslegerstück 3 / Jib element 3 / Élément de flèche 3		5,23	1,52	2,13	675	16,93
8	1	Auslegerstück 4 / Jib element 4 / Élément de flèche 4		5,23	1,52	2,13	585	16,93
9	1	Auslegerstück 5 / Jib element 5 / Élément de flèche 5		10,21	1,52	2,14	920	33,21
10	1	Auslegerstück 6 / Jib element 6 / Élément de flèche 6		2,40	1,41	2,72	385	9,21
11	1	Unterflasche U 6 / Hook block U 6 / Crochet U 6		0,40	0,36	0,92	230	0,13
12	27	Normgeländer / Standard handrail / Garde-corps		1,80	1,10	1,20	330	2,38
13	4	Gegengewichtssteine / Counterweight blocks / Blocs de contrepoids		2,27	0,48	2,28	5200	2,48
14	1	Kiste (Kleinteile) / Box (Loose parts) / Caisse à outils		1,00	1,00	1,00	150	1,00

Technische und inhaltliche Änderungen sind vorbehalten. / All rights reserved regarding technical and content changes. / Sous réserve de modifications techniques et de fond.

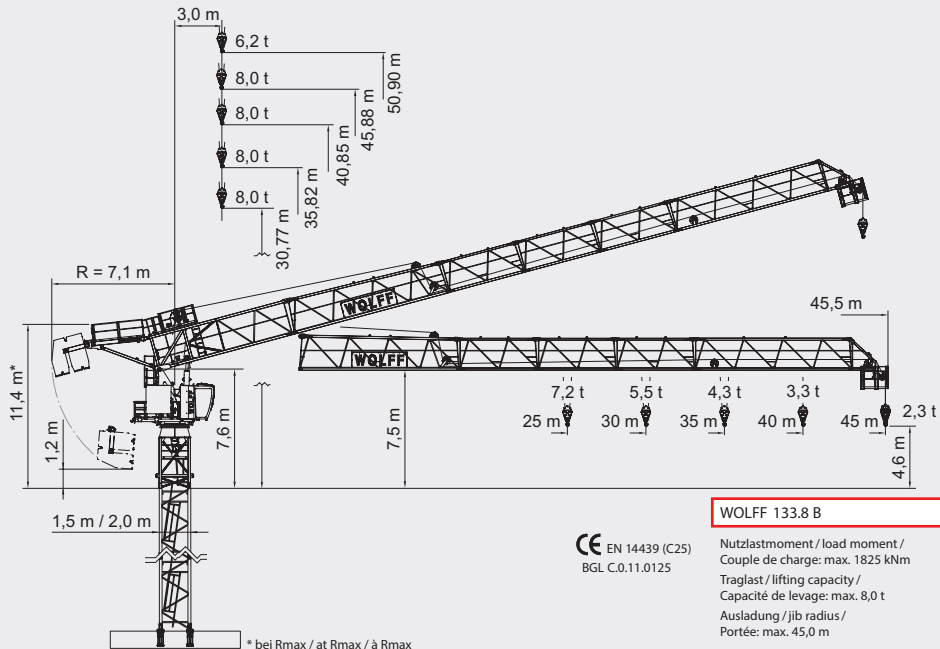

WOLFF 133.8 B

CE EN 14439 (C25)
BGL C.0.11.0125

Nutzlastmoment / load moment /
Couple de charge: max. 1825 kNm
Traglast / lifting capacity /
Capacité de levage: max. 8,0 t
Ausladung / jib radius /
Portée: max. 45,0 m



WOLFF 133 B Turmkombinationen · Tower configurations · Combinaisons de tour

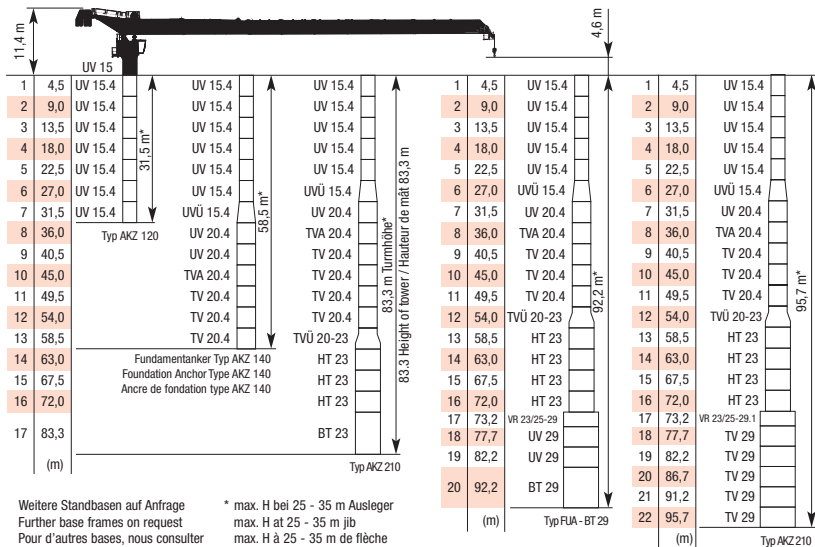

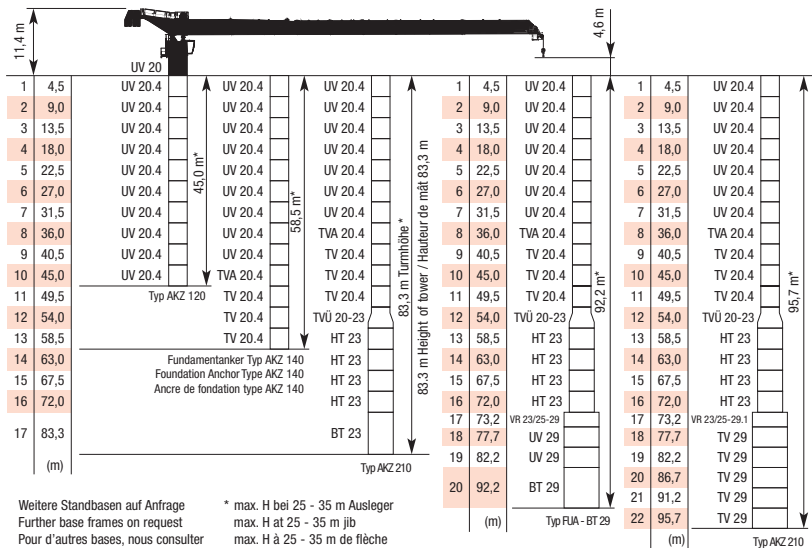

WOLFF 133 B Turmkombinationen · Tower configurations · Combinaisons de tour

Traglasten (t) · WOLFF 133.8 B

Load Data





Charges

Ausladung (m) / jib radius (m) / Portée (m)			20	25	30	35	40	45		
Auslegerlänge (m) jib length (m) Longueur de flèche (m)	45	3,0 - 30,4	 4,0 t	4,0	4,0	4,0	3,3	2,7	2,3	Tragfähigkeit (t) load capacity (t) Capacité de charge (t)
	40	3,0 - 35,2		4,0	4,0	4,0	4,0	3,3		
	35	3,0 - 35,0		4,0	4,0	4,0	4,0			
	30	3,0 - 30,0		4,0	4,0	4,0				
	25	3,0 - 25,0		4,0	4,0					
Ausladung (m) / jib radius (m) / Portée (m)			20	25	30	35	40	45		
Auslegerlänge (m) jib length (m) Longueur de flèche (m)	45	3,0 - 20,8	6,2 t	6,2	4,9	3,9	3,1	2,5	2,1	Tragfähigkeit (t) load capacity (t) Capacité de charge (t)
	40	3,0 - 20,5	 8,0 t	8,0	6,2	4,8	3,8	3,1		
	35	3,0 - 21,5		8,0	6,7	5,3	4,3			
	30	3,0 - 22,0		8,0	6,9	5,5				
	25	3,0 - 22,8		8,0	7,2					

















Antriebe · WOLFF 133.8 B · (Hw 845PL FU)

Mechanisms

Mécanismes

					
Motor [kW] motor Moteur	45	45	22	1 x 7,5	4 x 5,5
Geschwindigkeit speed Vitesse	0 - 1,0 t 0 ... 158 m/min stufenlos / stepless / en continue	0 - 2,5 t 0 ... 78 m/min stufenlos / stepless / en continue	1,5 min	0,8 min ⁻¹	30,0 m/min
Hakenweg [m] hook path Course du crochet	500	250			

WOLFF 133.8 B Kolli Liste - Colli List - Liste de colisage

Pos. Pos. Pos.	Stck. Pcs. Pcs.	Beschreibung / Description / Description	Kolli / Colli / Colis	L [m] Length Longueur	B [m] Width Largeur	H [m] Height Hauteur	Gewicht [kg] Weight Poids	Volumen [m³] Volume Volume
				UV 15 / TV 15				
				in Vorbereitung / in preparation / en préparation				
				UV 20				
1	1	Turmspitze komplett / Tower top complete / Pointe de tour complète		7,75	2,21	2,42	11410	41,45
	1	Verbindungsbock / Connection frame / Cadre de raccord <small>Pos. 1 zerlegt / Item 1 disassembled / Pos. 1 groupe mit Hydraulik / with hydraulic system / avec hydraulique</small>		3,28	1,58	2,52	5000	13,06
				UV 15 / TV 15				
				in Vorbereitung / in preparation / en préparation				
				UV 20				
	1	Turmspitzenunterteil / Tower top lower part / Pivot tournant <small>Pos. 1 zerlegt / Item 1 disassembled / Pos. 1 groupe</small>		5,76	2,21	2,42	6410	30,81
2	1	Führerhaustation / Driver's cabin with suspension / Cabine avec fixation <small>inkl. Schaltschrank / incl. switch cabinet / avec armoire de distribution</small>		5,12	1,84	2,52	2415	23,74
3	1	Gegenausleger / Counterjib / Contre-flèche		6,15	2,38	0,73	2800	10,69
4	1	Hubwinde Hw 845PL FU / Hoisting winch / Mécanisme de levage <small>mit Podest und Hubseil / with platform and hoisting rope / avec plateforme et câble de levage Ø 20 mm x 240 m = 480 kg</small>		3,14	2,29	1,01	2525	7,26
5	1	Auslegerstück 1 / Jib element 1 / Élément de flèche 1		9,44	1,63	2,54	4830	39,08
6	1	Auslegerstück 2 / Jib element 2 / Élément de flèche 2 <small>mit WOLFF Schild / with WOLFF sign / avec panneau WOLFF</small>		10,23	1,51	2,45	1945	37,85
7	1	Auslegerstück 3 / Jib element 3 / Élément de flèche 3		5,23	1,52	2,13	675	16,93
8	1	Auslegerstück 4 / Jib element 4 / Élément de flèche 4		5,23	1,52	2,13	585	16,93
9	1	Auslegerstück 5 / Jib element 5 / Élément de flèche 5		10,21	1,52	2,14	920	33,21
10	1	Auslegerstück 6 / Jib element 6 / Élément de flèche 6		2,40	1,41	2,72	385	9,21
11	1	Unterflasche U 8 / Hook block U 8 / Crochet U 8		0,60	0,35	1,30	500	0,27
12	27	Normgeländer / Standard handrail / Garde-corps		1,80	1,10	1,20	330	2,38
13	4	Gegengewichtssteine / Counterweight blocks / Blocs de contrepoids		2,27	0,48	2,28	5200	2,48
14	1	Kiste (Kleinteile) / Box (Loose parts) / Caisse à outils		1,00	1,00	1,00	150	1,00

Technische und inhaltliche Änderungen sind vorbehalten. / All rights reserved regarding technical and content changes. / Sous réserve de modifications techniques et de fond.

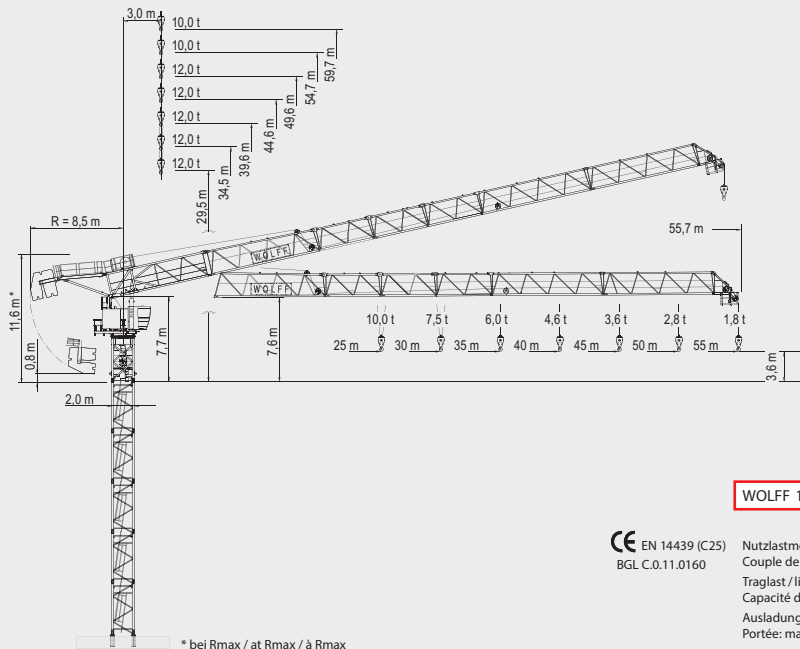

WOLFF 166 B



CE EN 14439 (C25) Nutzlastmoment / load moment /
 BGL C.0.11.0160 Couple de charge: max. 2520 kNm
 Traglast / lifting capacity /
 Capacité de levage: max. 12,0 t
 Ausladung / jib radius /
 Portée: max. 55,0 m

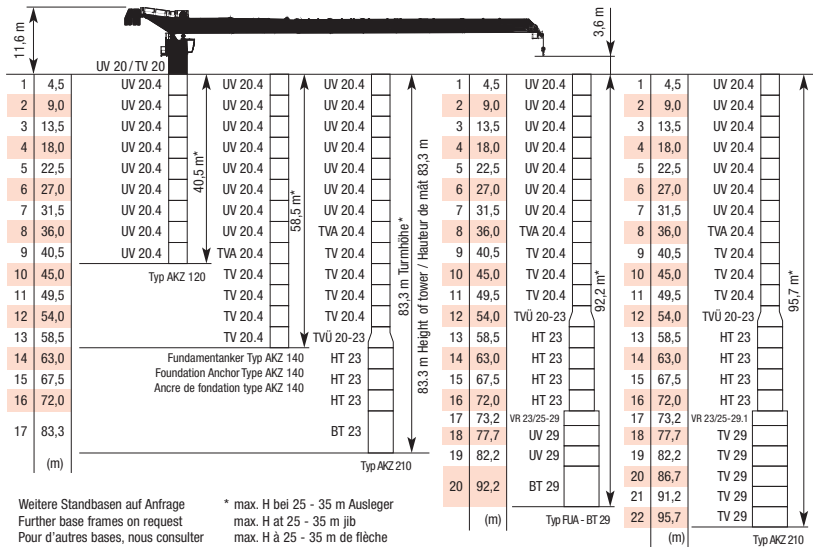

WOLFF 166 B Turmkombinationen · Tower configurations · Combinaisons de tour







Traglasten (t) · WOLFF 166 B
Load Data
Charges

Ausladung (m) / jib radius (m) / Portée (m)			20	25	30	35	40	45	50	55		
Auslegerlänge (m) jib length (m) Longueur de flèche (m)	55	3,0 - 28,3	 6,0 t	6,0	6,0	5,5	4,3	3,5	2,8	2,3	1,8	Tragfähigkeit (t) load capacity (t) Capacité de charge (t)
	50	3,0 - 31,2		6,0	6,0	6,0	5,1	4,1	3,4	2,8		
	45	3,0 - 32,0		6,0	6,0	6,0	5,3	4,3	3,6			
	40	3,0 - 33,0		6,0	6,0	6,0	5,5	4,6				
	35	3,0 - 35,0		6,0	6,0	6,0	6,0					
	30	3,0 - 30,0		6,0	6,0	6,0						
	25	3,0 - 25,0		6,0	6,0							
	Ausladung (m) / jib radius (m) / Portée (m)			20	25	30	35	40	45	50	55	
Auslegerlänge (m) jib length (m) Longueur de flèche (m)	55	3,0 - 19,0	10,0 t	9,4	6,9	5,3	4,1	3,3	2,6	2,0	1,6	Tragfähigkeit (t) load capacity (t) Capacité de charge (t)
	50	3,0 - 21,0		10,0	8,0	6,2	4,9	3,9	3,2	2,6		
	45	3,0 - 18,4	 12,0 t	10,8	8,2	6,4	5,1	4,1	3,4			
	40	3,0 - 18,7		11,1	8,4	6,6	5,4	4,4				
	35	3,0 - 19,3		11,5	8,9	7,1	5,8					
	30	3,0 - 20,0		12,0	9,3	7,5						
	25	3,0 - 21,0		12,0	10,0							

















Antriebe · WOLFF 166 B · (Hw 1260 FU)

Mechanisms

Mécanismes

					
Motor (kW) motor Moteur	60	60	22	7,5	4 x 5,5
Geschwindigkeit speed Vitesse	0 - 1,1 t 0 - 174 m/min stufenlos / stepless / en continue 0 - 6,0 t 0 - 47 m/min	0 - 2,9 t 0 - 87 m/min stufenlos / stepless / en continue 0 - 12,0 t 0 - 25 m/min	1,5 min	0,8 min ⁻¹	30,0 m/min
Hakenweg (m) hook path course du crochet	500	250			

WOLFF 166 B Kolli Liste - Colli list - Liste de colisage

Pos. Pos.	Stck. Pce. Pcs.	Beschreibung / Description / Description	Kolli / Colli / Colis	L (m) Length Longueur	B (m) Width Largeur	H (m) Height Hauteur	Gewicht (kg) Weight Poids	Volumen (m³) Volume Volume
1	1	Turmspitze komplett / Tower top complete / Pointe de tour complète		7,90	2,25	2,55	13120	45,33
	1	Verbindungsbock / Connection frame / Cadre de raccord <small>Pos. 1 zerlegt / Item 1 disassembled / Pos. 1 groupe</small> <small>mit Hydraulik / with hydraulic system / avec hydraulique</small>		3,30	1,45	2,50	5760	11,96
	1	Turmspitzenunterteil / Tower top lower part / Pivot tournant <small>Pos. 1 zerlegt / Item 1 disassembled / Pos. 1 groupe</small>		5,90	2,25	2,45	7360	32,52
2	1	Führerhaus / Operator's cabin / Cabine <small>mit Führerhausaufhängung / with cabin attachment / avec Fixation cabine</small>		5,20	1,90	2,55	2500	25,19
3	1	Gegenausleger geklappt / Counterjib folded / Contre-flèche repliée		4,90	2,15	1,25	4060	13,17
4	1	Hubwinde Hw1260FU / Hoist winch Hw1260FU / Treuil de levage Hw1260FU <small>mit Podest und Hubseil / with platform and hoisting rope / avec plateforme et câble de levage Ø 20 mm x 575 m = 1150 kg</small>		3,10	2,35	1,10	3020	8,01
5	1	Auslegerteil 1 / Jib part 1 / Élément de flèche 1		9,50	1,55	2,45	5270	36,08
6	1	Auslegerteil 2 / Jib part 2 / Élément de flèche 2		10,30	1,40	2,45	2330	35,33
7	2	Auslegerteil 3 / Jib part 3 / Élément de flèche 3		5,25	1,40	2,15	950	15,80
8	1	Auslegerteil 4 / Jib part 4 / Élément de flèche 4		5,25	1,40	2,15	830	15,80
9	1	Auslegerteil 5 / Jib part 5 / Élément de flèche 5		10,25	1,40	2,15	1520	30,85
10	1	Auslegerteil 6 / Jib part 6 / Élément de flèche 6		10,25	1,40	2,15	960	30,85
11	1	Auslegerteil 7 / Jib part 7 / Élément de flèche 7		2,45	1,45	2,95	450	10,48
12	1	Unterflasche U 8/16 / Hook block U 8/16 / Crochet U 8/16		1,45	0,65	0,30	620	0,28
13	1	Normgeländer / Standard handrail / Garde-corps		2,05	1,10	0,65	160	1,47
14	6	Gegengewichtssteine / Counterweight blocks / Blocs de contrepoids		2,30	0,50	2,35	5400	2,70

Technische und inhaltliche Änderungen sind vorbehalten. / All rights reserved regarding technical and content changes. / Sous réserve de modifications techniques et de fond.

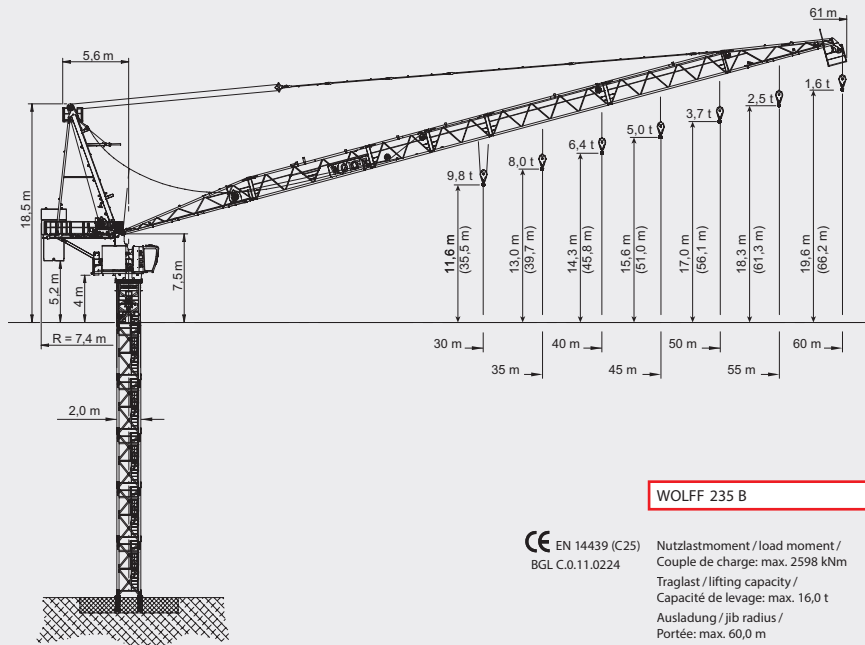

WOLFF 235 B

CE EN 14439 (C25) Nutzlastmoment / load moment /
 BGL C.0.11.0224 Couple de charge: max. 2598 kNm
 Traglast / lifting capacity /
 Capacité de levage: max. 16,0 t
 Ausladung / jib radius /
 Portée: max. 60,0 m

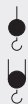

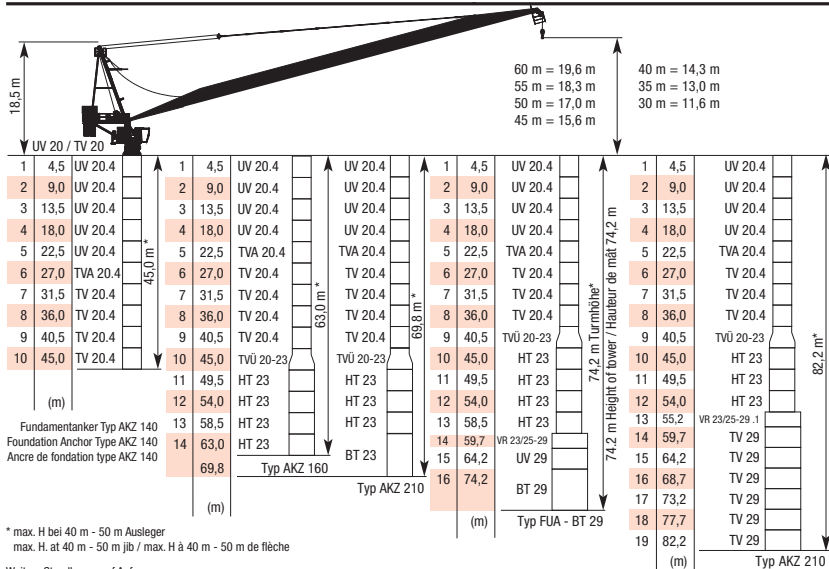

WOLFF 235 B Turmkombinationen - Tower configurations - Combinaisons de tour



Traglasten (t) · WOLFF 235 B

Load Data





Charges

Ausladung (m) / jib radius (m) / Portée (m)			20	25	30	35	40	45	50	55	60		
Auslegerlänge (m) jib length (m) Longueur de flèche (m)	60	6,0 - 26,5	 8,0	8,0	8,0	6,7	5,2	4,1	3,3	2,6	2,1	1,6	Tragfähigkeit (t) load capacity (t) Capacité de charge (t)
	55	5,5 - 28,0		8,0	8,0	7,3	5,8	4,6	3,8	3,1	2,5		
	50	5,0 - 29,5		8,0	8,0	7,8	6,4	5,3	4,4	3,7			
	45	4,5 - 31,0		8,0	8,0	8,0	6,9	5,8	5,0				
	40	4,0 - 33,0		8,0	8,0	8,0	7,5	6,4					
	35	3,5 - 35,0		8,0	8,0	8,0	8,0						
	30	3,5 - 30,0		8,0	8,0	8,0							
	60	6,0 - 20,0	10,0	10,0	7,4	5,6	4,3	3,4	2,7	2,1	1,6	1,2	
	55	5,5 - 18,0	12,0	10,5	7,9	6,1	4,9	3,9	3,2	2,6	2,1		
	50	5,0 - 16,5	 16,0	12,7	9,6	7,5	6,0	4,9	4,0	3,3			
	45	4,5 - 17,0		13,3	10,1	8,1	6,6	5,5	4,6				
	40	4,0 - 17,5		13,8	10,7	8,6	7,1	6,0					
	35	3,5 - 18,0		14,3	11,3	9,3	7,8						
	30	3,5 - 18,5		14,8	11,8	9,8							





































Antriebe · WOLFF 235 B · (Hw 1660 FU)

Mechanisms

Mécanismes

					
Motor [kW] motor Moteur	60	60	60	1 x 7,5	8 x 5,5
Geschwindigkeit speed Vitesse	0 - 2,0 t 0 ... 130 m/min stufenlos / stepless / en continue 0 - 8,0 t 0 ... 38 m/min	0 - 4,0 t 0 ... 65 m/min stufenlos / stepless / en continue 0 - 16,0 t 0 ... 19 m/min	1,3 ... 1,8 min	0,80 min ⁻¹	30,0 m/min
Hakenweg [m] hook path course du crochet	620	310			

WOLFF 235 B Kolli Liste · Colli List · Liste de colisage

Pos. Pos.	Stck. Pce. Pcs.	Beschreibung / Description / Description	Kolli / Colli / Colis	L [m] Length Longueur	B [m] Width Largeur	H [m] Height Hauteur	Gewicht [kg] Weight Poids	Volumen [m ³] Volume	
1	1	Turmspitzenoberteil / Tower top upper part / Port-flèche (inkl. Einziehwerk / incl. luffing gear / avec mécanisme de relevage)			12,02	2,58	2,61	9140	80,94
	1	Turmspitzenoberteil / Tower top upper part / Port-flèche (exkl. Einziehwerk / excl. luffing gear / sans mécanisme de relevage)			12,02	2,30	2,02	6190	55,84
2	1	Turmspitzenunterteil / Tower top lower part / Pivot tournament			8,79	2,71	2,56	12820	60,98
	1	Verbindungsbock / Connection block / Cadre de raccord Pos. 2 zerlegt / Item 2 disassembled / Pos. 2 désassemblé			3,52	2,30	2,48	3155	20,08
	1	Spitzenunterteiladapter / Adapter lower tower top / Adapter pivot tournante Pos. 2 zerlegt / Item 2 disassembled / Pos. 2 désassemblé			5,27	2,32	2,75	9665	33,62
3	1	Führerhausstation / Driver's cabin with suspension / Cabine avec fixation (inkl. Schaltschrank / incl. switch cabinet / avec armoire de distribution)			5,56	2,08	2,56	2490	29,61
4	1	Gegenausleger / Counterjib / Contre-flèche inkl. Podeste / incl. platforms / avec plateformes			7,04	2,33	0,88	3965	14,43
	1	Gegenausleger / Counterjib / Contre-flèche inkl. Podeste und Einziehwerk / incl. platforms and luffing gear / avec plateformes et mécanisme de relevage			7,04	2,33	2,09	6915	34,28
5	1	Auslegerstück 1 / Jib element 1 / Élément de flèche 1 (inkl. Hubwerk mit 2. Bremse und 285 m Hubseil / incl. hoist with 2. brake and 285 m hoisting rope / avec mécanisme de levage avec 2ème frein et 285 m câble de levage)			11,76	2,02	2,00	5190	68,68
6	1	Auslegerstück 2 / Jib element 2 / Élément de flèche 2 (mit WOLFF Schild / with WOLFF sign / avec panneau WOLFF)			10,56	1,73	2,06	1750	37,63
7	1	Auslegerstück 3 / Jib element 3 / Élément de flèche 3			5,39	1,96	1,73	1080	18,28
8	1	Auslegerstück 4 / Jib element 4 / Élément de flèche 4			5,39	1,96	1,73	870	18,28
9	1	Auslegerstück 5 / Jib element 5 / Élément de flèche 5			10,56	2,01	1,73	1290	36,72
10	1	Auslegerstück 6 / Jib element 6 / Élément de flèche 6			10,56	1,96	1,73	1225	35,81
11	1	Auslegerstück 7 / Jib element 7 / Élément de flèche 7 (inkl. Montagepodeste / incl. assembly platforms / avec plateformes de montage)			9,99	1,94	1,98	1690	38,37
12	1	Unterflasche U8/16 / Hook block U8/16 / Crochet U8/16			1,43	0,60	0,35	590	0,30
13	1	Abspannstäbe / Braces / Tirants (60 m Ausleger / 60 m jib / 60 m flèche)			10,48	0,72	0,22	725	1,62
14	1	Kiste (Kleinteile) / Box (Loose parts) / Caisse à outils			1,00	1,00	1,00	385	1,00

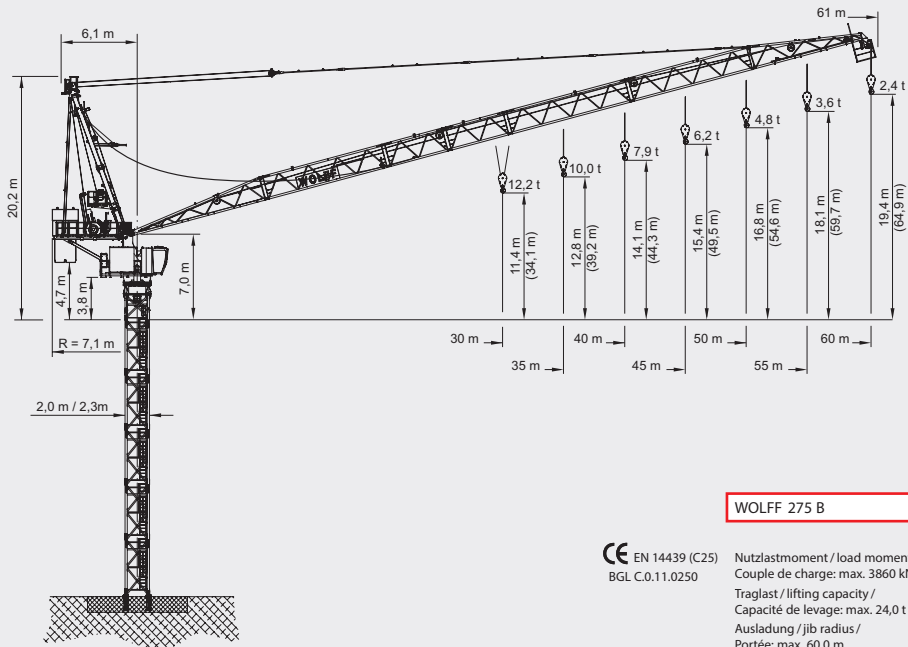

WOLFF 275 B

CE EN 14439 (C25)
BGL C.0.11.0250

Nutzlastmoment / load moment /
Couple de charge: max. 3860 kNm
Traglast / lifting capacity /
Capacité de levage: max. 24,0 t
Ausladung / jib radius /
Portée: max. 60,0 m

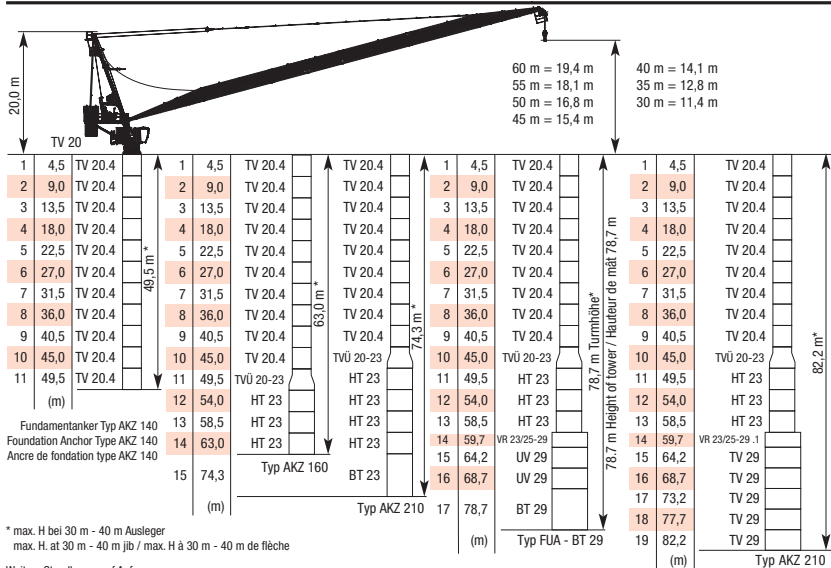

WOLFF 275 B Turmkombinationen - Tower configurations - Combinaisons de tour

WOLFF 275 B Turmkombinationen - Tower configurations - Combinaisons de tour



1	4,5	HT 23		1	4,5	HT 23		1	4,5	HT 23		1	4,5	HT 23	
2	9,0	HT 23		2	9,0	HT 23		2	9,0	HT 23		2	9,0	HT 23	
3	13,5	HT 23		3	13,5	HT 23		3	13,5	HT 23		3	13,5	HT 23	
4	18,0	HT 23		4	18,0	HT 23		4	18,0	HT 23		4	18,0	HT 23	
5	22,5	HT 23		5	22,5	HT 23		5	22,5	HT 23		5	22,5	HT 23	
6	27,0	HT 23		6	27,0	HT 23		6	27,0	HT 23		6	27,0	HT 23	
7	31,5	HT 23		7	31,5	HT 23		7	31,5	HT 23		7	31,5	HT 23	
8	36,0	HT 23		8	36,0	HT 23		8	36,0	HT 23		8	36,0	HT 23	
9	40,5	HT 23		9	40,5	HT 23		9	40,5	HT 23		9	40,5	HT 23	
10	45,0	HT 23		10	45,0	HT 23		10	45,0	HT 23		10	45,0	HT 23	
11	49,5	HT 23		11	49,5	HT 23		11	49,5	HT 23		11	49,5	HT 23	
12	54,0	HT 23		12	54,0	HT 23		12	54,0	HT 23		12	54,0	HT 23	
13	58,5	HT 23		13	58,5	HT 23		13	58,5	HT 23		13	58,5	HT 23	
14	63,0	HT 23		14	69,8	BT 23		14	59,7	VR 23/25-29		14	59,7	VR 23/25-29.1	
	(m)				(m)	Typ AKZ 210		15	64,2	UV 29		15	64,2	TV 29	
								16	68,7	UV 29		16	68,7	TV 29	
								17	78,7	BT 29		17	73,2	TV 29	
										Typ FUA - BT 29		18	77,7	TV 29	
												19	82,2	TV 29	
													(m)		Typ AKZ 210

63,0 m*

69,8 m*

78,7 m Turmhöhe* / Hauteur de mât 78,7 m

82,2 m*



Fundamentanker Typ AKZ 160
Foundation Anchor Type AKZ 160
Ancre de fondation type AKZ 160

* max. H bei 30 m - 40 m Ausleger
max. H. at 30 m - 40 m jib / max. H à 30 m - 40 m de flèche
Weitere Standbasen auf Anfrage
Further base frames on request / Pour d'autres bases, nous consulter

Traglasten (t) - WOLFF 275 B

Load Data





Charges

Ausladung (m) / jib radius (m) / Portée (m)			20	25	30	35	40	45	50	55	60		
Auslegerlänge (m) jib length (m) Longueur de flèche (m)	60	7,8 - 24,9	 12,0	12,0	11,9	9,2	7,3	5,8	4,7	3,8	3,0	2,4	Tragfähigkeit (t) load capacity (t) Capacité de charge (t)
	55	7,1 - 25,8		12,0	12,0	9,8	7,8	6,4	5,3	4,3	3,6		
	50	6,5 - 26,6		12,0	12,0	10,3	8,3	6,9	5,7	4,8			
	45	5,8 - 27,5		12,0	12,0	10,8	8,8	7,3	6,2				
	40	5,2 - 28,6		12,0	12,0	11,3	9,4	7,9					
	35	4,6 - 29,9		12,0	12,0	12,0	10,0						
	30	3,9 - 30,0		12,0	12,0	12,0							
	60	7,8 - 21,8	14,0	14,0	11,6	8,9	7,0	5,5	4,4	3,5	2,7	2,1	
	55	7,1 - 18,4	18,0	16,2	12,2	9,5	7,5	6,1	4,9	4,0	3,3		
	50	6,5 - 15,9	22,0	16,7	12,7	9,9	8,0	6,5	5,4	4,5			
	45	5,8 - 15,1	 24,0	17,3	13,2	10,5	8,5	7,0	5,9				
	40	5,2 - 15,4		17,9	13,8	11,0	9,1	7,6					
	35	4,6 - 15,8		18,5	14,4	11,7	9,7						
	30	3,9 - 16,1		19,0	14,9	12,2							





















Antriebe · WOLFF 275 B · (Hw 2475 FU)

Mechanisms

Mécanismes

					
Motor [kW] motor Moteur	75	75	60	1 x 7,5	8 x 5,5
Geschwindigkeit speed Vitesse	0 - 1,1 t 0 ... 222 m/min stufenlos / stepless / en continue 0 - 12,0 t 0 ... 31,5 m/min	0 - 2,8 t 0 ... 111 m/min stufenlos / stepless / en continue 0 - 24,0 t 0 ... 16 m/min	1,3 ... 1,8 min	0,81 min ⁻¹	30,0 m/min
Hakenweg [m] hook path course du crochet	700	350			

WOLFF 275 B Kolli Liste · Colli List · Liste de colisage

Pos. Pos.	Stck. Pce. Pcs.	Beschreibung / Description / Description	Kolli / Colli / Colis	L [m] Length Longueur	B [m] Width Largeur	H [m] Height Hauteur	Gewicht [kg] Weight Poids	Volumen [m³] Volume Volume
1	1	Turmspitzenoberteil / Tower top upper part / Port-flèche (inkl. Ew 1460FU, Abspannung) / incl. Ew 1460FU, Braces / avec Ew 1460FU, haubancs (zerlegbar / sectionnable / démontable possible)		12,71	2,30	2,92	11455	85,36
2	1	Turmspitzenunterteil / Tower top lower part / Pivot tournant		8,03	2,71	2,56 TV 20	14755	55,71
		Verbindungsbock / Connection block / Cadre de raccord Pos. 2 zerlegt / Item 2 disassembled / Pos. 2 groupe		8,22	2,71	2,81 HT 23	16075	62,60
	1	Drehrahmen / Slewing frame / Pivot tournant Pos. 2 zerlegt / Item 2 disassembled / Pos. 2 groupe		4,17	2,25	2,48	3350	23,34
	1	Spitzenunterteilladapter / Adapter lower tower top / Adapter pivot tournante Pos. 2 zerlegt / Item 2 disassembled / Pos. 2 groupe		2,71	2,30	2,41	9445	15,08
	1	Spitzenunterteilladapter / Adapter lower tower top / Adapter pivot tournante Pos. 2 zerlegt / Item 2 disassembled / Pos. 2 groupe		2,43	2,24	2,11 TV 20	1960	11,49
3	1	Führerhausstation / Driver's cabin with suspension / Cabine avec fixation (inkl. Schaltschrank / incl. switch cabinet / avec armoire de distribution)		2,80	2,32	2,30 HT 23	3280	14,94
		Gegenausleger / Counterjib / Contre-flèche (inkl. Podeste / incl. platforms / avec plateformes)		5,56	2,08	2,56	2865	29,61
4	1	Gegenausleger / Counterjib / Contre-flèche (inkl. Podeste / incl. platforms / avec plateformes)		6,64	2,30	0,84	3935	12,83
5	1	Hubwinde Hw 2475 FU / Hoisting winch / Mécanisme de levage (inkl. Seilberuhigung, 2. Bremse und 820 m Hubseil / incl. rope-slow down device, 2nd brake and 820 m hoisting rope / avec stabilisation du câble, 2ème frein et 820 m câble de levage)		2,62	2,06	2,47	8235	13,33
6	1	Auslegerstück 1 / Jib element 1 / Élément de flèche 1		11,76	2,19	1,97	2460	50,74
7	1	Auslegerstück 2 / Jib element 2 / Élément de flèche 2 (mit WOLFF Schild / with WOLFF sign / avec panneau WOLFF)		10,56	1,73	1,96	1780	35,81
8	1	Auslegerstück 3 / Jib element 3 / Élément de flèche 3		5,39	1,73	1,96	960	18,28
9	1	Auslegerstück 4 / Jib element 4 / Élément de flèche 4		5,39	1,73	1,96	880	18,28
10	1	Auslegerstück 5 / Jib element 5 / Élément de flèche 5		10,56	1,73	1,96	1380	35,81
11	1	Auslegerstück 6 / Jib element 6 / Élément de flèche 6		10,56	1,73	1,96	1260	35,81
12	1	Auslegerstück 7 / Jib element 7 / Élément de flèche 7 (inkl. Montagepodeste / incl. assembly platforms / avec plateformes de montage)		10,13	1,73	1,98	1900	34,70
13	1	Unterflasche / Hook block / Crochet		0,68	0,26	1,66	535	0,29
14	1	Abspannstäbe / Braces / Barres de hauban (60 m Ausleger / 60 m jib / 60 m flèche)		10,48	0,71	0,18	1245	1,34
15		Normgeländer / Standard railings / Garde-corps		1,10	2,00	1,98	515	4,36
16	1	Kiste (Kleinteile) / Box (loose parts) / Caisse à outils		1,00	1,00	1,00	150	1,00

Technische und inhaltliche Änderungen sind vorbehalten. / All rights reserved regarding technical and content changes. / Sous réserve de modifications techniques et de fond.

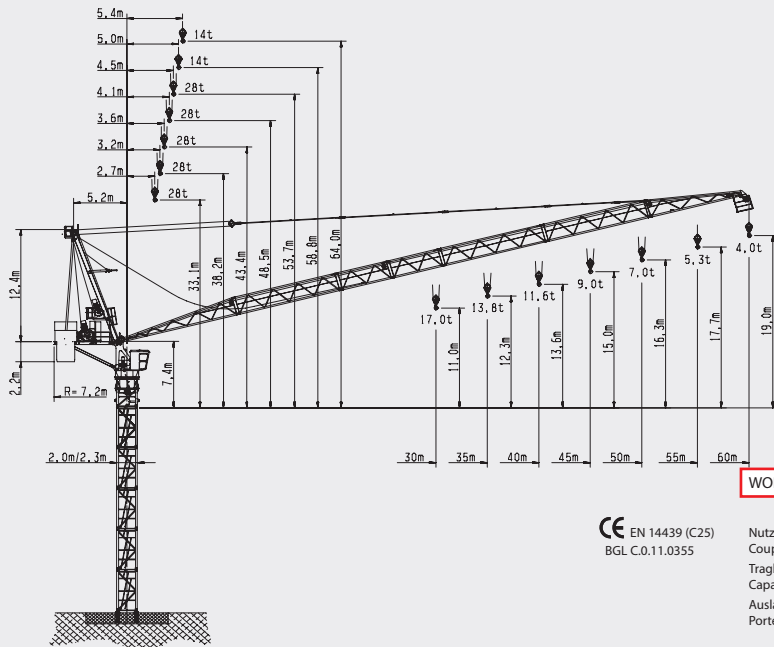

WOLFF 355 B

CE EN 14439 (C25)
BGL C.0.11.0355

Nutzlastmoment / load moment /
Couple de charge: max. 5100 kNm
Traglast / lifting capacity /
Capacité de levage: max. 28,0 t
Ausladung / jib radius /
Portée: max. 60,0 m



WOLFF 355 B Turmkombinationen - Tower configurations - Combinaisons de tour

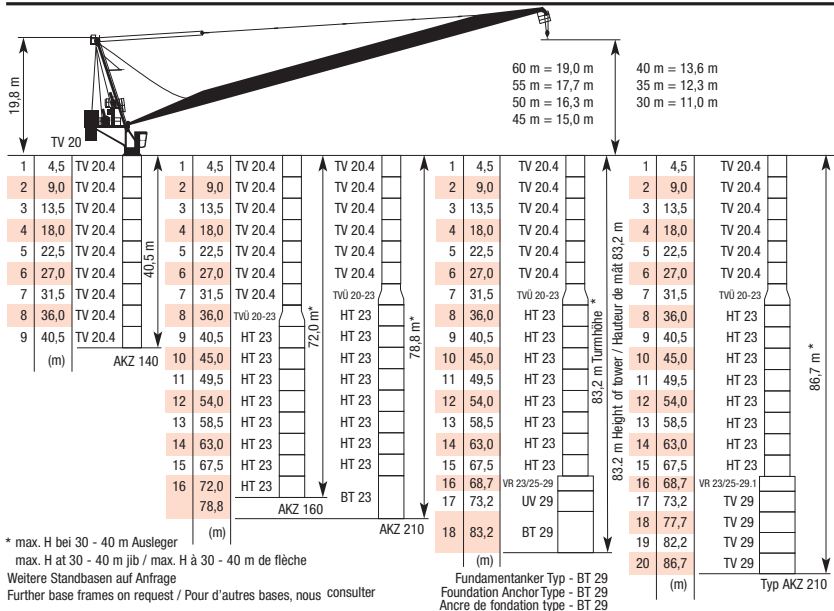

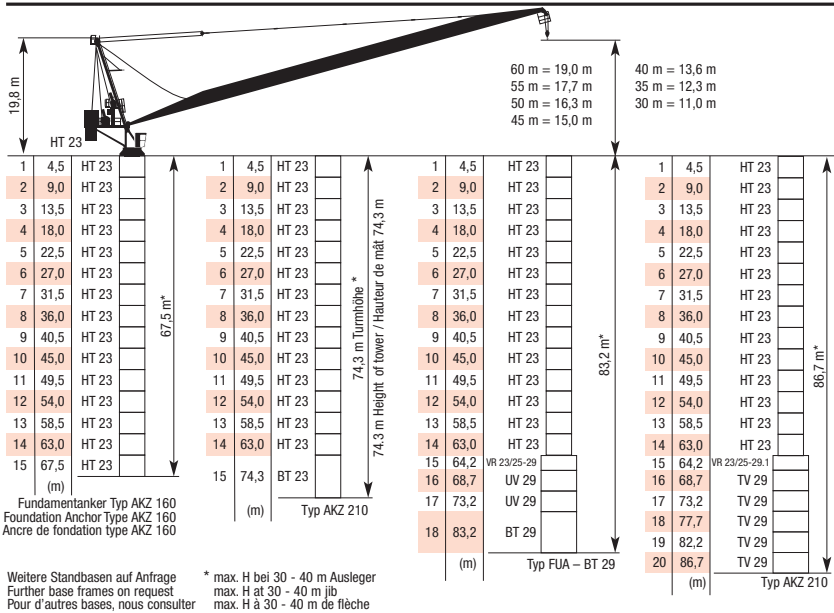

WOLFF 355 B Turmkombinationen - Tower configurations - Combinaisons de tour



Traglasten (t) · WOLFF 355 B

Load Data





Charges

Ausladung (m) / jib radius (m) / Portée (m)			20	25	30	35	40	45	50	55	60		
Auslegerlänge (m) jib length (m) Longueur de fleche (m)	60	5,4 – 27,0	 14,0 t	14,0	14,0	12,2	9,8	8,1	6,7	5,6	4,7	4,0	Tragfähigkeit (t) load capacity (t) Capacité de charge (t)
	55	5,0 – 28,0		14,0	14,0	12,8	10,5	8,7	7,3	6,2	5,3		
	50	4,5 – 29,5		14,0	14,0	13,7	11,3	9,5	8,1	7,0			
	45	4,1 – 31,0		14,0	14,0	14,0	12,2	10,4	9,0				
	40	3,6 – 33,5		14,0	14,0	14,0	13,4	11,6					
	35	3,2 – 34,5		14,0	14,0	14,0	13,8						
	30	2,7 – 30,0		14,0	14,0	14,0							
	60												
55													
Auslegerlänge (m) jib length (m) Longueur de fleche (m)	50	4,5 – 16,0	 28,0 t	21,7	16,7	13,4	11,0	9,2	7,8	6,7			Tragfähigkeit (t) load capacity (t) Capacité de charge (t)
	45	4,1 – 16,5		22,7	17,6	14,3	11,9	10,1	8,7				
	40	3,6 – 17,0		23,6	18,7	15,4	13,1	11,3					
	35	3,2 – 17,5		24,4	19,3	15,9	13,5						
	30	2,7 – 18,0		25,3	20,3	17,0							

Antriebe · WOLFF 355 B · (Hw 28110 FU)

Mechanisms





Mécanismes

					
Motor (kW) motor Moteur	110	110	75,0	7,5	6 x 5,5
Geschwindigkeit speed Vitesse	0 – 2,5 t 0...185 m/min stufenlos / stepless / en continue 0 – 14,0 t 0...40 m/min	0 – 5,5 t 0...92 m/min stufenlos / stepless / en continue 0 – 28,0 t 0...20 m/min	1,80 min	0,80 min ⁻¹	25,0 m/min
Hakenweg (m) hook path course du crochet	920	460			











Antriebe · WOLFF 355 B · (Hw 28132 FU)

Mechanisms

Mécanismes

					
Motor (kW) motor Moteur	132	132	75,0	7,5	6 x 5,5
Geschwindigkeit speed Vitesse	0 – 1,7 t 0...290 m/min stufenlos / stepless / en continue 0 – 14,0 t 0...48 m/min	0 – 4,0 t 0...146 m/min stufenlos / stepless / en continue 0 – 28,0 t 0...25 m/min	1,80 min	0,80 min ⁻¹	25,0 m/min
Hakenweg (m) hook path course du crochet	920	460			

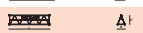
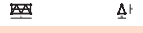
WOLFF 355 B Kolli Liste - Colli List - Liste de colisage

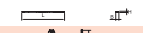
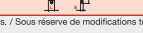
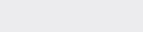
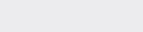
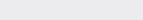
Pos. Pos.	Stk. Pcs.	Beschreibung / Description / Description	Kolli / Colli / Colis	L (m) Length Longueur	B (m) Width Largeur	H (m) Height Hauteur	Gewicht (kg) Weight Poids	Volumen (m³) Volume Volume
1	1	Turmspitzenoberteil / Tower top upper part / Porte-flèche		13,36	2,30	2,52	9800	77,44
2	1	Turmspitzenunterteil kompl. / Tower top lower part complete / Pivot tournant complète		7,96	2,30	2,53	15300	46,32
		Turmspitzenunterteil / Tower top lower part / Pivot tournant <small>Pos. 2 zerlegt / Item 2 disassembled / Pos. 2 groupe</small>		8,12	2,32	2,80	16600	52,75
3	1	Führerhausaufhängung / Driver's cabin suspension / Fixation cabine		5,63	2,30	2,53	11700	32,76
		Führerhaus / Driver's cabin / Cabine		5,82	2,32	2,80	12995	37,81
4	1	Gegenausleger / Counterjib / Contre-flèche mit Podesten / with platforms / avec plateformes		2,80	2,07	0,51	400	2,96
				2,26	1,45	2,30	940	7,54
5	1	Maschinenplattform Hw28110FU / Machinery platform / Plateforme avec mécanisme de Levage		6,58	2,30	0,93	5150	14,08
6	1	Maschinenplattform Hw28132FU / Machinery platform / Plateforme avec mécanisme de Levage		2,31	2,19	2,41	8200	12,12
7	1	Seilberuhigung / Rope swing-reduction device		2,98	2,56	2,81	11196	21,44
8	1	Auslegerteil 1 / Jib part 1 / Élément de flèche 1		2,71	1,39	0,52	215	1,96
9	1	Auslegerteil 2 mit WOLFF Schild / Jib part 2 with WOLFF plate / Élément de flèche 2 avec panneau WOLFF		11,92	2,22	2,00	2250	52,93
10	1	Auslegerteil 3 / Jib part 3 / Élément de flèche 3		10,56	1,71	1,96	1710	35,40
11	1	Auslegerteil 4 / Jib part 4 / Élément de flèche 4		5,39	1,71	1,96	960	18,07
12	2	Auslegerteil 5 / Jib part 5 / Élément de flèche 5		5,39	1,71	1,96	930	18,07
13	1	Auslegerteil 6 / Jib part 6 / Élément de flèche 6		10,56	1,71	1,96	1630	35,40
14	5	Abspannlaschen / Bracing brackets / Tirants		10,16	1,71	1,99	2020	34,58
15	1	Unterflasche 28 t / Hook block 28 t / Crochet 28 t		10,51	0,24	0,61	1350	1,54
15	1	Unterflasche 28 t / Hook block 28 t / Crochet 28 t		0,68	0,26	1,63	540	0,29

Technische und inhaltliche Änderungen sind vorbehalten. / All rights reserved regarding technical and content changes. / Sous réserve de modifications techniques et de fond.

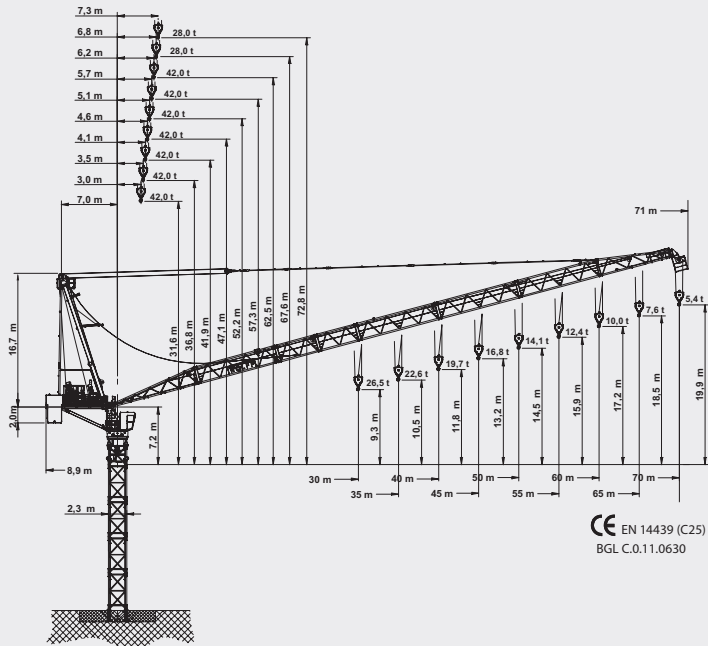

WOLFF 630 B

CE EN 14439 (C25)
BGL C.0.11.0630



Nutzlastmoment / load moment /
Couple de charge: max. 8000 kNm
Traglast / lifting capacity /
Capacité de levage: max. 42,0 t
Ausladung / jib radius /
Portée: max. 70,0 m



Traglasten (t) · WOLFF 630 B

Load Data

Charges

Ausladung (m) / jib radius (m) / Portée (m)			20	25	30	35	40	45	50	55	60	65	70		
Auslegerlänge (m) jib length (m) Longueur de flèche (m)	70	7,3 – 37,0	 14,0 t	14,0	14,0	14,0	14,0	12,6	10,8	9,3	8,0	7,0	6,1	5,4	Tragfähigkeit (t) load capacity (t) Capacité de charge (t)
	65	6,8 – 42,0		14,0	14,0	14,0	14,0	14,0	12,8	11,1	9,7	8,6	7,6		
	60	6,2 – 46,0		14,0	14,0	14,0	14,0	14,0	14,0	12,6	11,2	10,0			
	55	5,7 – 49,0		14,0	14,0	14,0	14,0	14,0	14,0	13,7	12,4				
	50	5,1 – 50,0		14,0	14,0	14,0	14,0	14,0	14,0	14,0					
	45	4,6 – 45,0		14,0	14,0	14,0	14,0	14,0	14,0						
	40	4,1 – 40,0		14,0	14,0	14,0	14,0	14,0							
	35	3,5 – 35,0		14,0	14,0	14,0	14,0								
	30	3,0 – 30,0		14,0	14,0	14,0									
Ausladung (m) / jib radius (m) / Portée (m)			20	25	30	35	40	45	50	55	60	65	70		
Auslegerlänge (m) jib length (m) Longueur de flèche (m)	70	7,3 – 20,0	 28,0 t	28,0	21,4	17,0	13,9	11,6	9,7	8,3	7,1	6,1	5,2	4,5	Tragfähigkeit (t) load capacity (t) Capacité de charge (t)
	65	6,8 – 22,5		28,0	24,7	19,9	16,4	13,8	11,7	10,1	8,8	7,6	6,7		
	60	6,2 – 24,0		28,0	26,7	21,7	18,1	15,4	13,3	11,6	10,3	9,1			
	55	5,7 – 25,0		28,0	28,0	23,0	19,4	16,7	14,6	12,9	11,5				
	50	5,1 – 26,0		28,0	28,0	24,1	20,6	17,9	15,8	14,1					
	45	4,6 – 27,0		28,0	28,0	25,2	21,6	18,9	16,8						
	40	4,1 – 28,0		28,0	28,0	26,2	22,5	19,7							
	35	3,5 – 28,5		28,0	28,0	26,6	22,6								
	30	3,0 – 28,5		28,0	28,0	26,5									

Traglasten (t) • WOLFF 630 B

Load Data







Charges

Ausladung (m) / jib radius (m) / Portée (m)		20	25	30	35	40	45	50	55	60	65	70			
Auslegerlänge (m) jib length (m) Longueur de flèche (m)	60	6,2 – 16,0	 42,0 t												
	55	5,7 – 16,5													
	50	5,1 – 17,0		32,8	25,4	20,4	16,9	14,3	12,2	10,6	9,2	8,1			
	45	4,6 – 17,5		34,1	26,7	21,8	18,2	15,6	13,5	11,9	10,5				
	40	4,1 – 18,0		35,4	28,0	23,0	19,5	16,8	14,8	13,1					
	35	3,5 – 18,5		36,6	29,1	24,1	20,6	17,9	15,8						
	30	3,0 – 18,5		37,8	30,1	25,1	21,4	18,7							
				38,8	30,8	25,4	21,6								
		38,8	30,8	25,5											
													Tragfähigkeit (t) load capacity (t) Capacité de charge (t)		

Antriebe · WOLFF 630 B · (Hw 28110 FU)

Mechanisms







Mécanismes

						
Motor (kW) motor Moteur	110	110	110	110	2 x 7,5	6 x 5,5
Geschwindigkeit speed Vitesse	0 – 2,1 t 0...200 m/min stufenlos/ stepless/ en continue 0 – 14,0 t 0...40 m/min	0 – 4,5 t 0...100 m/min stufenlos/ stepless/ en continue 0 – 28,0 t 0...20 m/min	0 – 7,0 t 0...66 m/min stufenlos/ stepless/ en continue 0 – 42,0 t 0...13 m/min	1,8 – 2,8 min	0,7 min ⁻¹	25,0 m/min
Hakenweg (m) hook path course du crochet	920	460	306			



























Antriebe · WOLFF 630 B · (Hw 28132 FU)

Mechanisms

Mécanismes

						
Motor (kW) motor Moteur	132	132	132	110	2 x 7,5	6 x 5,5
Geschwindigkeit speed Vitesse	0 – 1,5 t 0...304 m/min stufenlos / stepless / en continue 0 – 14,0 t 0...47 m/min	0 – 3,4 t 0...152 m/min stufenlos / stepless / en continue 0 – 28,0 t 0...24 m/min	0 – 5,2 t 0...101 m/min stufenlos / stepless / en continue 0 – 42,0 t 0...16 m/min	1,8 – 2,8 min	0,7 min ⁻¹	25,0 m/min
Hakenweg (m) hook path course du crochet	920	460	306			

WOLFF 630 B Kollif Liste - Colli List - Liste de collisage

Pos. Pos. Pos.	Stück. Pcs. Pcs.	Beschreibung / Description / Description	Kolli / Colli / Colis	L (m) Length Longueur	B (m) Width Largeur	H (m) Height Hauteur	Gewicht (kg) Weight Poids	Volumen (m³) Volume Volume
1	1	Turmspitzenoberenteil / Tower top upper part / Porte-flèche		11,95	2,50	2,57	9500	76,78
2	1	Turmspitzenabspannung / Tower top bracing / Tirants pointe		10,18	0,72	0,43	1600	3,15
3	1	Turmspitzenunterteil / Tower top lower part / Pivot tournant		8,52	3,05	2,66	20400	69,12
	1	Verbindungsbock / Connection frame / Cadre de raccord		4,27	2,35	2,30	4500	23,08
	1	Drehrahmen / Slewing frame / Pivot tournant		2,32	2,57	2,97	13300	17,71
	1	Spitzenunterteiladapter / Adapter lower tower top / Adapter pivot tournant		2,32	2,80	2,52	2600	14,73
4	1	Führerhausaufhängung / Cabin attachment / Fixation cabine		2,72	2,00	0,57	400	3,10
	1	Führerhaus / Operator's cabin / Cabine		2,26	1,45	2,30	940	7,54
5	1	Gegenausleger / Counterjib / Contre-flèche		8,05	2,50	1,09	5900	21,94
6	1	Ew 12110 FU Maschinenplattform / Machinery platform / Plateforme avec mécanisme de levage		1,82	2,23	2,60	4700	10,55
7	1	Maschinenplattform / Machinery platform / Plateforme avec mécanisme de levage Hw 28110 FU (mit Hubseil / with hoist rope / avec le câble de levage ø 26 mm x 920 m = 3000 kg) Hw 28132 FU (In Vorbereitung / In preparation / En préparation)		2,60	4,26	2,24	11900	24,81
8	1	Kiste (Kleinteile) / Box (small parts) / Caisse à outils		0,63	0,50	0,38	100	1,12
9	1	Normgeländer / Standard railings / Garde-corps		2,60	1,10	0,65	300	1,86
10	1	Auslegerteil 1 / Jib part 1 / Élément de flèche 1		11,88	2,53	2,25	4100	67,63
11	1	Auslegerteil 2 / Jib part 2 / Élément de flèche 2		10,60	1,98	2,20	3000	46,17
12	1	Auslegerteil 3 / Jib part 3 / Élément de flèche 3		5,43	1,98	2,20	1600	23,65
13	1	Auslegerteil 4 / Jib part 4 / Élément de flèche 4		5,43	1,98	2,20	1400	23,65
14	1	Auslegerteil 5 / Jib part 5 / Élément de flèche 5		10,60	1,98	2,20	2400	46,17
15	2	Auslegerteil 6 / Jib part 6 / Élément de flèche 6		10,60	1,98	2,20	2100	46,17
16	1	Auslegerteil 7 / Jib part 7 / Élément de flèche 7		10,75	1,98	2,23	3500	47,47
17	1	Montagepodest (zu Pos.16) / Assembly platform (to item 16) / Passerelle de montage (à Pos.16)		3,10	0,50	1,50	500	2,33
18		Unterflasche / Hook block / Crochet		1,08	0,34	1,99	600	0,73
				1,20	0,40	1,99	1000	0,96
				1,20	0,50	1,99	1500	1,20
19	1	Abspannstäbe / Braces / Tirants		10,53	0,60	0,19	2200	1,20
20	1	Ausbaukran / Service crane / Grue de service		3,37	0,40	3,43	300	4,62

Technische und inhaltliche Änderungen sind vorbehalten. / All rights reserved regarding technical and content changes. / Sous réserve de modifications techniques et de fond.

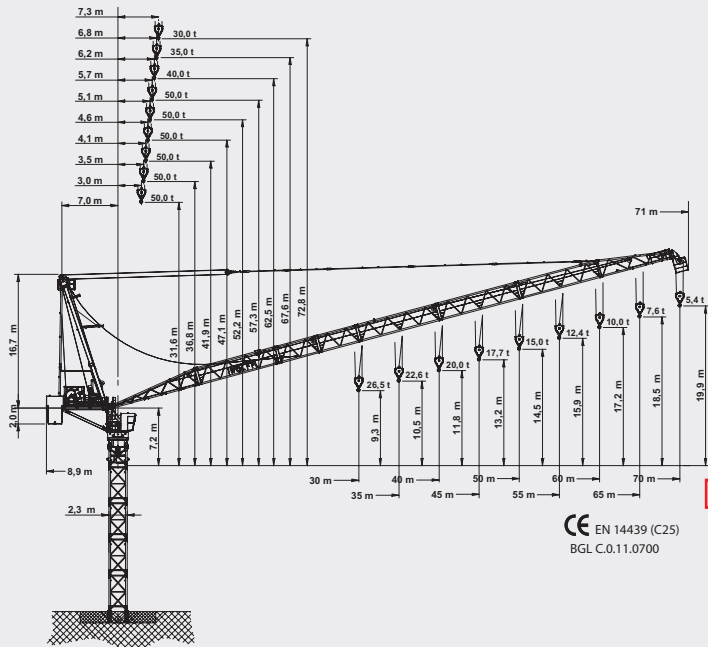

WOLFF 700 B

CE EN 14439 (C25)
BGL C.0.11.0700

Nutzlastmoment / load moment /
Couple de charge: max. 8000 kNm
Traglast / lifting capacity /
Capacité de levage: max. 50,0 t
Ausladung / jib radius /
Portée: max. 70,0 m



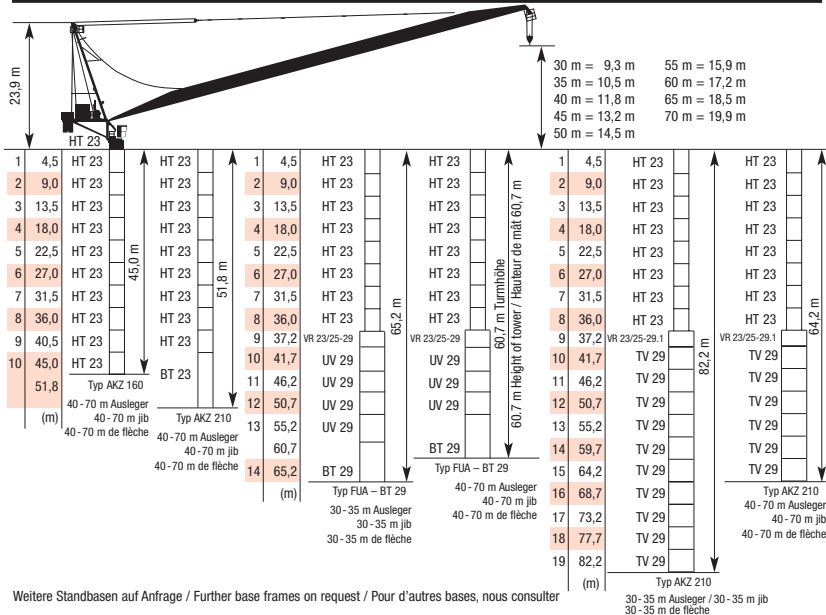

WOLFF 700B Turmkombinationen · Tower configurations · Combinaisons de tour



Traglasten (t) - WOLFF 700 B

Load Data







Charges

Ausladung (m) / jib radius (m) / Portée (m)			20	25	30	35	40	45	50	55	60	65	70		
Auslegerlänge (m) jib length (m) Longueur de flèche (m)	70	7,3 – 28,0	 20,0 t	20,0	20,0	18,4	15,1	12,7	10,8	9,3	8,1	7,0	6,2	5,4	Tragfähigkeit (t) load capacity (t) Capacité de charge (t)
	65	6,8 – 31,5		20,0	20,0	20,0	17,6	14,9	12,8	11,1	9,7	8,6	7,6		
	60	6,2 – 34,0		20,0	20,0	20,0	19,3	16,5	14,4	12,6	11,2	10,0			
	55	5,7 – 35,5		20,0	20,0	20,0	20,0	17,6	15,5	13,8	12,4				
	50	5,1 – 37,5		20,0	20,0	20,0	20,0	18,8	16,7	15,0					
	45	4,6 – 39,5		20,0	20,0	20,0	20,0	19,8	17,7						
	40	4,1 – 40,0		20,0	20,0	20,0	20,0	20,0							
	35	3,5 – 35,0		20,0	20,0	20,0	20,0								
30	3,0 – 30,0	20,0	20,0	20,0											
Ausladung (m) / jib radius (m) / Portée (m)			20	25	30	35	40	45	50	55	60	65	70		
Auslegerlänge (m) jib length (m) Longueur de flèche (m)	70	7,3 – 19,0	 40,0 t	28,3	21,6	17,2	14,0	11,6	9,8	8,3	7,1	6,1	5,2	4,5	Tragfähigkeit (t) load capacity (t) Capacité de charge (t)
	65	6,8 – 18,5		32,0	24,7	19,8	16,4	13,7	11,7	10,1	8,8	7,6	6,7		
	60	6,2 – 17,5		34,6	26,9	21,8	18,2	15,5	13,3	11,6	10,3	9,1			
	55	5,7 – 18,0		35,8	28,1	23,1	19,4	16,7	14,6	12,9	11,5				
	50	5,1 – 18,5		36,9	29,3	24,2	20,6	17,9	15,8	14,1					
	45	4,6 – 19,0		38,0	30,4	25,3	21,6	18,9	16,8						
	40	4,1 – 19,5		39,0	31,3	26,1	22,5	19,7							
	35	3,5 – 20,0		40,0	31,9	26,5	22,6								
30	3,0 – 20,0	40,0	31,9	26,5											



























Antriebe · WOLFF 700 B · (Hw 40132 FU)

Mechanisms

Mécanismes

						
Motor (kW) motor Moteur	132	132	132	110	2 x 7,5	8 x 5,5
Geschwindigkeit speed Vitesse	0 – 2,9 t 0...190 m/min stufenlos/ stepless/ en continue 0 – 20,0 t 0...33 m/min	0 – 6,2 t 0...95 m/min stufenlos/ stepless/ en continue 0 – 40,0 t 0...17 m/min	0 – 9,3 t 0...63 m/min stufenlos/ stepless/ en continue 0 – 50,0 t 0...13 m/min	1,8 – 2,8 min	0,7 min ⁻¹	30,0 m/min
Hakenweg (m) hook path course du crochet	990	495	330			

WOLFF 700 B Kollifliste - Colli List - Liste de colisage

Pos. Pos. Pos.	Stck. Pce. Pcs.	Beschreibung / Description / Description	Kolli / Colli / Colis	L (m) Length Longueur	B (m) Width Largeur	H (m) Height Hauteur	Gewicht (kg) Weight Poids	Volumen (m³) Volume Volume
1	1	Turmspitzenoberteil / Tower top upper part / Porte-flèche		11,95	2,50	2,57	9500	76,78
2	1	Turmspitzenabspannung / Tower top bracing / Tirants pointe		10,18	0,72	0,43	1600	3,15
3	1	Turmspitzenunterteil / Tower top lower part / Pivot tournant		8,52	3,05	2,66	20400	69,12
	1	Verbindungsbock / Connection frame / Cadre de raccord		4,27	2,35	2,30	4500	23,08
	1	Drehrahmen / Slewing frame / Pivot tournant		2,32	2,57	2,97	13300	17,71
	1	Spitzenunterteiladapter / Adapter lower tower top / Adapter pivot tournant		2,32	2,80	2,52	2600	14,73
4	1	Führerhausaufhängung / Cabin attachment / Fixation cabine		2,72	2,00	0,57	400	3,10
	1	Führerhaus / Operator's cabin / Cabine		2,26	1,45	2,30	940	7,54
5	1	Gegenausleger / Counterjib / Contre-flèche		8,05	2,50	1,09	5900	21,94
6	1	Ew 12110 FU Maschinerplattform / Machinery platform / Plateforme avec mécanisme de levage		1,82	2,23	2,60	4700	10,55
7	1	Hw 40132 FU Maschinerplattform / Machinery platform / Plateforme avec mécanisme de levage (mit Hülse) / with hoist rope / avec le câble de levage ø 32 mm x 1000 m = 5000 kg)		4,85	2,60	2,45	17500	30,89
8	1	Kiste (Kleinteile) / Box (small parts) / Caisse à outils		0,63	0,50	0,38	100	1,12
9	1	Normgeländer / Standard railings / Garde-corps		2,60	1,10	0,65	300	1,86
10	1	Auslegerteil 1 / Jib part 1 / Élément de flèche 1		11,88	2,53	2,25	4100	67,63
11	1	Auslegerteil 2 / Jib part 2 / Élément de flèche 2		10,60	1,98	2,20	3000	46,17
12	1	Auslegerteil 3 / Jib part 3 / Élément de flèche 3		5,43	1,98	2,20	1600	23,65
13	1	Auslegerteil 4 / Jib part 4 / Élément de flèche 4		5,43	1,98	2,20	1400	23,65
14	1	Auslegerteil 5 / Jib part 5 / Élément de flèche 5		10,60	1,98	2,20	2400	46,17
15	2	Auslegerteil 6 / Jib part 6 / Élément de flèche 6		10,60	1,98	2,20	2100	46,17
16	1	Auslegerteil 7 / Jib part 7 / Élément de flèche 7		10,75	1,98	2,23	3500	47,47
17	1	Montagepodest (zu Pos.19) / Assembly platform (to item 19) / Passerelle de montage (à Pos.19)		3,10	0,50	1,50	500	2,33
18		Unterflasche / Hook block / Crochet		1,08	0,34	1,99	600	0,73
				1,20	0,40	1,99	1000	0,96
				1,20	0,50	1,99	1500	1,20
19	1	Abspannstäbe / Braces / Tirants		10,53	0,60	0,19	2200	1,20
20	1	Ausbaukran / Service crane / Grue de service		3,37	0,40	3,43	300	4,62

Technische und inhaltliche Änderungen sind vorbehalten. / All rights reserved regarding technical and content changes. / Sous réserve de modifications techniques et de fond.

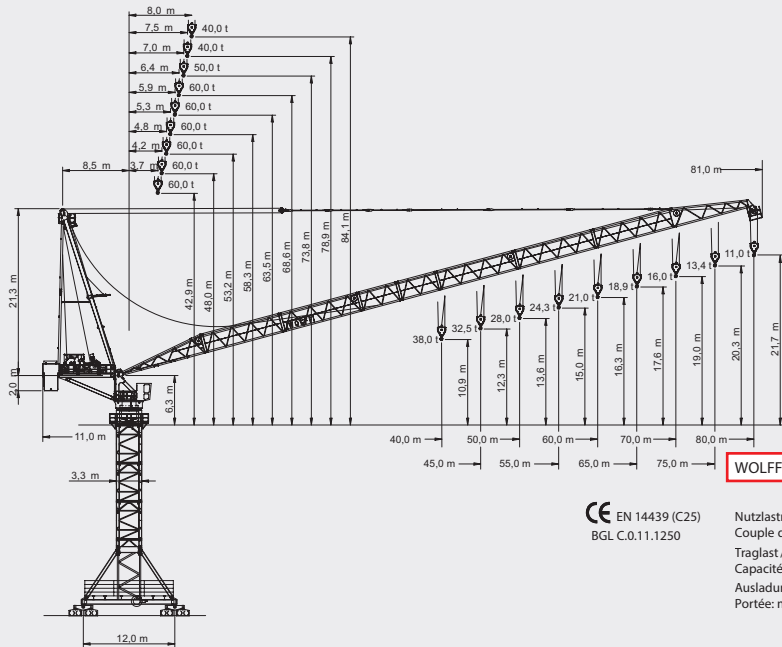

WOLFF 1250 B

CE EN 14439 (C25)
BGL C.0.11.1250

Nutzlastmoment / load moment /
Couple de charge: max. 15000 kNm
Traglast / lifting capacity /
Capacité de levage: max. 60,0 t
Ausladung / jib radius /
Portée: max. 80,0 m



WOLFF 1250 B Turmkombinationen · Tower configurations · Combinaisons de tour

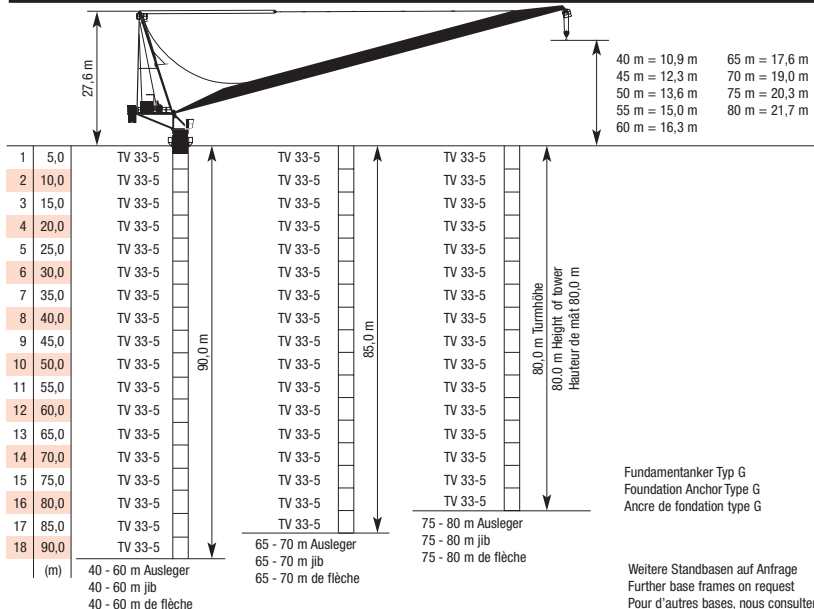

Traglasten (t) · WOLFF 1250 B

Load Data

Charges

Ausladung (m) / jib radius (m) / Portée (m)			30	35	40	45	50	55	60	65	70	75	80	
Auslegerlänge (m) jib length (m) Longueur de flèche (m)	80	8,0 – 52,0	20,0	20,0	20,0	20,0	20,0	18,6	16,6	14,9	13,4	12,1	11,0	Tragfähigkeit (t) load capacity (t) Capacité de charge (t)
	75	7,5 – 55,5	20,0	20,0	20,0	20,0	20,0	18,1	16,3	14,7	13,4			
	70	7,0 – 59,0	20,0	20,0	20,0	20,0	20,0	19,6	17,7	16,0				
	65	6,4 – 61,5	20,0	20,0	20,0	20,0	20,0	20,0	18,9					
	60	5,9 – 60,0	20,0	20,0	20,0	20,0	20,0	20,0						
	55	5,3 – 55,0	20,0	20,0	20,0	20,0	20,0							
	50	4,8 – 50,0	20,0	20,0	20,0	20,0								
	45	4,2 – 45,0	20,0	20,0	20,0									
	40	3,7 – 40,0	20,0	20,0										



Traglasten (t) • WOLFF 1250 B

Load Data

Charges

Ausladung (m) / jib radius (m) / Portée (m)			30	35	40	45	50	55	60	65	70	75	80		
Auslegerlänge (m) jib length (m) Longueur de flèche (m)	80	8,0 – 29,0	 40,0 t	38,4	31,9	27,1	23,3	20,2	17,8	15,7	13,9	12,4	11,1	10,0	Tragfähigkeit (t) load capacity (t) Capacité de charge (t)
	75	7,5 – 30,5		40,0	34,0	29,0	25,0	21,9	19,3	17,1	15,3	13,8	12,4		
	70	7,0 – 32,0		40,0	36,1	30,8	26,7	23,4	20,7	18,5	16,6	15,0			
	65	6,4 – 33,0		40,0	37,4	32,1	28,0	24,7	22,0	19,8	17,9				
	60	5,9 – 34,0		40,0	38,8	33,4	29,3	26,0	23,3	21,0					
	55	5,3 – 35,0		40,0	40,0	34,6	30,4	27,1	24,3						
	50	4,8 – 36,0		40,0	40,0	35,7	31,4	28,0							
	45	4,2 – 37,0		40,0	40,0	36,8	32,5								
	40	3,7 – 38,0		40,0	40,0	38,0									

Traglasten (t) · WOLFF 1250 B

Load Data







Charges

Ausladung (m) / jib radius (m) / Portée (m)			30	35	40	45	50	55	60	65	70	75	80		
Auslegerlänge (m) jib length (m) Longueur de flèche (m)	70	7,0 – 26,0	50,0 t	42,4	35,3	30,0	25,8	22,5	19,8	17,6	15,6	14,0		Tragfähigkeit (t) load capacity (t) Capacité de charge (t)	
	65	6,4 – 22,5		43,5	36,5	31,2	27,0	23,8	21,1	18,8	16,9				
	60	5,9 – 23,0		44,9	37,8	32,4	28,3	25,0	22,3	20,0					
	55	5,3 – 23,5		46,1	39,0	33,6	29,4	26,0	23,3						
	50	4,8 – 24,0		47,3	40,1	34,6	30,4	27,0							
	45	4,2 – 24,5		60,0 t	48,5	41,2	35,8	31,5							
	40	3,7 – 25,0			49,8	42,5	37,0								























Antriebe · WOLFF 1250 B · (Hw 40132 FU)

Mechanisms

Mécanismes

						
Motor (kW) motor Moteur	132	132	132	110,0	2 x 11,0	8 x 5,5
Geschwindigkeit speed Vitesse	0 – 2,9 t 0...190 m/min stufenlos / stepless / en continue 0 – 20,0 t 0...33 m/min	0 – 6,2 t 0...95 m/min stufenlos / stepless / en continue 0 – 40,0 t 0...17 m/min	0 – 9,3 t 0...63 m/min stufenlos / stepless / en continue 0 – 60,0 t 0...11 m/min	2,5 – 3,5 min	0,70 min ⁻¹	30,0 m/min
Hakenweg (m) hook path course du crochet	990	495	330			

WOLFF 1250 B Kolli Liste - Colli List - Liste de colisage

Pos. Pos.	Stck. Pcs.	Beschreibung / Description / Description	Kolli / Colli / Colis	L (m) Length Longueur	B (m) Width Largeur	H (m) Height Hauteur	Gewicht (kg) Weight Poids	Volumen (m³) Volume Volume
1	1	Turmspitzenoberteil / Tower top upper part / Porte-flèche		11,90	2,50	2,82	13100	83,90
2	1	Turmspitzenabspannung / Tower top bracing / Tirants pointe		10,48	0,99	0,49	2900	5,08
3	1	Turmspitzenunterteil / Tower top lower part / Pivot tournant		3,33	3,79	3,53	23700	44,55
4	1	Verbindungsbock / Connection frame / Cadre de raccord		4,98	2,54	2,80	7300	35,41
5	1	Führerhausaufhängung / Cabin attachment / Fixation cabine		3,58	2,23	0,56	560	4,47
1		Führerhaus / Operator's cabin / Cabine		2,26	1,45	2,30	940	7,54
6	1	Gegenausleger / Counterjib / Contre-flèche		9,81	2,50	1,25	8500	30,66
7	1	Ew 16110 FU Maschinenplattform / Machinery platform / Plateforme avec mécanisme de levage		2,03	2,23	2,50	6200	11,32
8	1	Hw 40132 FU Maschinenplattform / Machinery platform / Plateforme avec mécanisme de levage (mit Hubsail / with hoist rope / avec le câble de levage ø 32 mm x 1000 m = 5000 kg)		2,60	4,85	2,39	17500	30,14
9	1	Kiste (Kleinteile) / Box (small parts) / Caisse à outils		0,63	0,50	0,38	100	1,12
10	1	Normgeländer / Standard railings / Garde-corps		2,60	1,10	0,65	300	1,86
11	1	Auslegerteil 1 / Jib part 1 / Élément de flèche 1		11,89	2,55	2,51	4400	76,10
12	1	Auslegerteil 2 / Jib part 2 / Élément de flèche 2		10,59	2,03	2,50	3100	53,74
13	1	Auslegerteil 3 / Jib part 3 / Élément de flèche 3		10,59	2,03	2,50	3200	53,74
14	1	Auslegerteil 4 / Jib part 4 / Élément de flèche 4		5,41	2,03	2,50	1600	27,46
15	1	Auslegerteil 5 / Jib part 5 / Élément de flèche 5		5,41	2,03	2,50	1600	27,46
16	1	Auslegerteil 6 / Jib part 6 / Élément de flèche 6		10,59	2,03	2,50	2600	53,74
17	1	Auslegerteil 7 / Jib part 7 / Élément de flèche 7		10,59	2,03	2,50	2500	53,74
18	1	Auslegerteil 8 / Jib part 8 / Élément de flèche 8		11,13	2,03	2,52	3800	56,94
19		Unterflasche / Hook block / Crochet		1,08	0,34	1,99	600	0,73
				1,20	0,40	1,99	1000	0,96
				1,20	0,50	1,99	1500	1,20
20	1	Abspannstäbe / Braces / Tirants		10,58	0,74	0,27	3200	2,11

Technische und inhaltliche Änderungen sind vorbehalten. / All rights reserved regarding technical and content changes. / Sous réserve de modifications techniques et de fond.

WOLFF Elektrische Anschlusswerte · Turmkrane mit Laufkatzausleger

Electric connection values · Tower cranes with trolley jib / Puissance électrique · Grue à tour à flèche horizontale

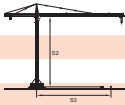
KranTyp Crane Type Type de grue	4518 City	5014 City		5020 Clear				6020 Clear				
Hubwerk Hoisting gear / Mécanisme de levage		318 FU	628.1 FU		628 FU		845 FU		628.1 FU		845 FU	
Leistung (kW) / Power (kW) / Puissance (kW)	18	28	28	28	45	28	45	28	45	28	45	
Strom (A) / Current (A) / Courant (A)	33	52	52	56	88	52	84	52	84	52	84	
Betriebsstrom (A) Operating current (A) / Courant de fonction (A)	36	49	49	63	86	65	87	65	87	65	87	
Spitzenstrom (A) Peak current (A) / Courant de fonction (A)	58	75	75	98	139	103	141	103	141	103	141	
Querschnitt A (mm ²) Cross section A (mm ²) / Section de câble A (mm ²)	10	10	16	16	25	35	50	25	35	35	50	
max. Vorsicherung (A) / max. fuse In (A) / Fusible (A)	50	50	50	63	63	100	100	80	80	100	100	
Oder Einstellung Leistungsschalter (A) Alternatively setting-up power switch (A) Ou disjoncteur de puissance (A)	36	49	49	63	63	86	86	65	65	87	87	
Max. Länge S2 + S3 (m) Max. length S2 + S3 (m) / Longueur max. S2 + S3 (m)	130	98	156	122	191	194	277	167	234	182	260	
Anschlussleistung (kVA) Connected power (kVA) Puissance électrique nécessaire au branchement (kVA)	25	34	34	44	59	45	60	45	60	45	60	
Min. erforderliche Generator-Nennleistung (kVA) Min. required generator power (kVA) Branchement min. sur génératrice (kVA)	50	68	68	88	118	90	120	90	120	90	120	
frequenzgeregelt frequency controlled drives / Fréquence de rotation limitée	x	x	x	x	x	x	x	x	x	x	x	

WOLFF Elektrische Anschlusswerte · Turmkrane mit Laufkatzausleger

Electric connection values · Tower cranes with trolley jib / Puissance électrique · Grue à tour à flèche horizontale

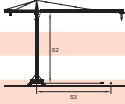
Krantyp Crane Type Type de grue	6023 Clear						7032 Clear				6031 Clear			
	Hubwerk Hoisting gear / Mécanisme de levage													
Leistung (kW) / Power (kW) / Puissance (kW)	28	45	75	45	75	45	75	45	75	45	75	45	75	
Strom (A) / Current (A) / Courant (A)	56	88	143	88	143	88	143	88	143	88	143	88	143	
Betriebsstrom (A) Operating current (A) / Courant de fonction (A)	68	90	130	90	130	90	130	99	139	99	139	99	139	
Spitzenstrom (A) Peak current (A) / Courant de fonction (A)	111	152	221	152	221	158	227	158	227	158	227	158	227	
Querschnitt A (mm ²) Cross section A (mm ²) / Section de câble A (mm ²)	25	35	35	50	50	70	35	50	50	70	35	50	50	70
max. Vorsicherung (A) / max. fuse In (A) / Fusible (A)	80	80	100	100	125	125	100	100	125	125	100	100	125	125
Oder Einstellung Leistungsschalter (A) Alternatively setting-up power switch (A) Ou disjoncteur de puissance (A)	68	68	90	90	130	130	90	90	130	130	99	99	139	139
Max. Länge S2 + S3 (m) Max. length S2 + S3 (m) / Longueur max. S2 + S3 (m)	154	216	158	226	155	217	172	246	169	237	151	216	150	210
Anschlussleistung (kVA) Connected power (kVA) Puissance électrique nécessaire au branchement (kVA)	47	62	90	62	90	68	96	68	96	68	96	68	96	
Min. erforderliche Generator-Nennleistung (kVA) Min. required generator power (kVA) Branchement min. sur génératrice (kVA)	94	124	180	124	180	136	192	136	192	136	192	136	192	
frequenzgeregelt frequency controlled drives / Fréquence de rotation limitée	x	x	x	x	x	x	x	x	x	x	x	x	x	x

WOLFF Elektrische Anschlusswerte · Turmkrane mit Laufkatzausleger

Electric connection values · Tower cranes with trolley jib / Puissance électrique · Grue à tour à flèche horizontale

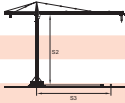
Krantyp Crane Type Type de grue	7534 Clear				8033 Cross						6071 Cross			
		845 FU		875 FU		875 FU		2075 FU		20110 FU		2075 FU		
Hubwerk Hoisting gear / Mécanisme de levage														
Leistung (kW) / Power (kW) / Puissance (kW)		45		75		75		75		110		75		
Strom (A) / Current (A) / Courant (A)		88		143		143		143		198		143		
Betriebsstrom (A) Operating current (A) / Courant de fonction (A)		95		134		141		142		181		142		
Spitzenstrom (A) Peak current (A) / Courant de fonction (A)		148		215		235		239		301		213		
Querschnitt A (mm ²) Cross section A (mm ²) / Section de câble A (mm ²)		35	50	50	70	50	70	50	70	70	95	50	70	
max. Vorsicherung (A) / max. fuse In (A) / Fusible (A)		100	100	125	125	125	125	125	125	160	160	125	125	
Oder Einstellung Leistungsschalter (A) Alternatively setting-up power switch (A) Ou disjoncteur de puissance (A)		95	95	134	134	141	141	142	142	181	181	142	142	
Max. Länge S2 + S3 (m) Max. length S2 + S3 (m) / Longueur max. S2 + S3 (m)		177	253	174	244	160	224	157	220	176	239	162	227	
Anschlussleistung (kVA) Connected power (kVA) Puissance électrique nécessaire au branchement (kVA)		66		93		97		98		125		98		
Min. erforderliche Generator-Nennleistung (kVA) Min. required generator power (kVA) Branchement min. sur génératrice (kVA)		132		186		194		245		312		245		
frequenzgeregelt frequency controlled drives / Fréquence de rotation limitée		x		x		x		x		x		x		

WOLFF Elektrische Anschlusswerte · Turmkrane mit Laufkatzausleger

Electric connection values · Tower cranes with trolley jib / Puissance électrique · Grue à tour à flèche horizontale

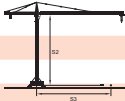
Krantomtyp Crane Type Type de grue	8060 Cross		8076 Comapct			
Hubwerk Hoisting gear / Mécanisme de levage			20110 FU			
Leistung (kW) / Power (kW) / Puissance (kW)			110		132	
Strom (A) / Current (A) / Courant (A)			198		240	
Betriebsstrom (A) Operating current (A) / Courant de fonction (A)			190		229	
Spitzenstrom (A) Peak current (A) / Courant de fonction (A)	311		372			
Querschnitt A (mm ²) Cross section A (mm ²) / Section de câble A (mm ²)	70	95	95	120		
max. Vorsicherung (A) / max. fuse In (A) / Fusible (A)	200	200	200	200		
Oder Einstellung Leistungsschalter (A) Alternatively setting-up power switch (A) Ou disjoncteur de puissance (A)	190	190	229	229		
Max. Länge S2 + S3 (m) Max. length S2 + S3 (m) / Longueur max. S2 + S3 (m)	154	209	191	241		
Anschlussleistung (kVA) Connected power (kVA) Puissance électrique nécessaire au branchement (kVA)	131		158			
Min. erforderliche Generator-Nennleistung (kVA) Min. required generator power (kVA) Branchement min. sur génératrice (kVA)	328		400			
frequenzgeregelt frequency controlled drives / Fréquence de rotation limitée	x		x			

WOLFF Elektrische Anschlusswerte · Turmkrane mit Wippausleger

Electric connection values · Tower cranes with luffing jib / Puissance électrique · Grue à tour à flèche relevable

Krantyp Crane Type Type de grue	133.6 B		133.8 B		166 B		235 B		275 B			
Hubwerk / Hoisting gear / Mécanisme de levage			628.1 FU		845PL FU		1260 FU		1660 FU		2475 FU	
Leistung (kW) / Power (kW) / Puissance (kW)			28		45		60		60		75	
Strom (A) / Current (A) / Courant (A)			52		81		110		108		139	
Einziehwerk / Luffing gear / Mécanisme de relevage de la flèche			hydr.		hydr.		hydr.		1660 FU		760 FU	
Leistung (kW) / Power (kW) / Puissance (kW)			22		22		22		60		60	
Strom (A) / Current (A) / Courant (A)			52		52		52		108		111	
Betriebsstrom (A) Operating current (A) / Courant de fonction (A)	90		110		132		170		194			
Spitzenstrom (A) Peak current (A) / Courant de fonction (A)	124		159		196		220		258			
Querschnitt A (mm ²) Cross section A (mm ²) / Section de câble A (mm ²)	35	50	35	50	50	70	70	95	70	95		
max. Vorsicherung (A) / max. fuse In (A) / Fusible (A)	100	100	100	100	125	125	160	160	160	160		
Oder Einstellung Leistungsschalter (A) Alternatively setting-up power switch (A) / Ou disjoncteur de puissance (A)	90	90	110	110	132	132	170	170	194	194		
Max. Länge S2 + S3 (m) Max. length S2 + S3 (m) / Longueur max. S2 + S3 (m)	218	311	168	240	196	279	249	338	212	287		
Anschlussleistung (kVA) Connected power (kVA) / Puissance électrique nécessaire au branchement (kVA)	62		76		91		118		134			
Min. erforderliche Generator-Nennleistung (kVA) Min. required generator power (kVA) / Branchement min. sur génératrice (kVA)	124		152		182		236		268			
frequenzgeregelt frequency controlled drives / Fréquence de rotation limitée	x		x		x		x		x			

WOLFF Elektrische Anschlusswerte · Turmkrane mit Wippausleger

Electric connection values · Tower cranes with luffing jib / Puissance électrique · Grue à tour à flèche relevable

KranTyp Crane Type Type de grue	355 B				630 B				700 B		1250 B							
Hubwerk / Hoisting gear / Mécanisme de levage																		
Leistung (kW) / Power (kW) / Puissance (kW)													28110 FU	28132 FU	28110 FU	28132 FU	40132 FU	40132 FU
Strom (A) / Current (A) / Courant (A)													110	132	110	132	132	132
Einziehwerk / Luffing gear / Mécanisme de relevage de la flèche													1575 FU	1575 FU	12110 FU	12110 FU	12110 FU	16110 FU
Leistung (kW) / Power (kW) / Puissance (kW)	75		110		110		110											
Strom (A) / Current (A) / Courant (A)	150		200		200		200											
Betriebsstrom (A) Operating current (A) / Courant de fonction (A)	280	295	309	339	339	347												
Spitzenstrom (A) Peak current (A) / Courant de fonction (A)	337	407	405	455	455	457												
Querschnitt A (mm ²) Cross section A (mm ²) / Section de câble A (mm ²)	95	120	120	185	120	185	120	185	120	185	120	185						
max. Vorsicherung (A) / max. fuse In (A) / Fusible (A)	200	200	315	315	315	315	355	355	355	355	355	355						
Oder Einstellung Leistungsschalter (A) Alternatively setting-up power switch (A) / Ou disjoncteur de puissance (A)	280	280	295	295	309	309	339	339	339	339	347	347						
Max. Länge S2 + S3 (m) Max. length S2 + S3 (m) / Longueur max. S2 + S3 (m)	208	263	226	348	229	352	202	312	202	312	193	297						
Anschlussleistung (kVA) Connected power (kVA) / Puissance électrique nécessaire au branchement (kVA)	194		205		214		235		235		241							
Min. erforderliche Generator-Nennleistung (kVA) Min. required generator power (kVA) / Branchement min. sur génératrice (kVA)	485		513		535		588		588		603							
frequenzgeregelt frequency controlled drives / Fréquence de rotation limitée	x		x		x		x		x		x							

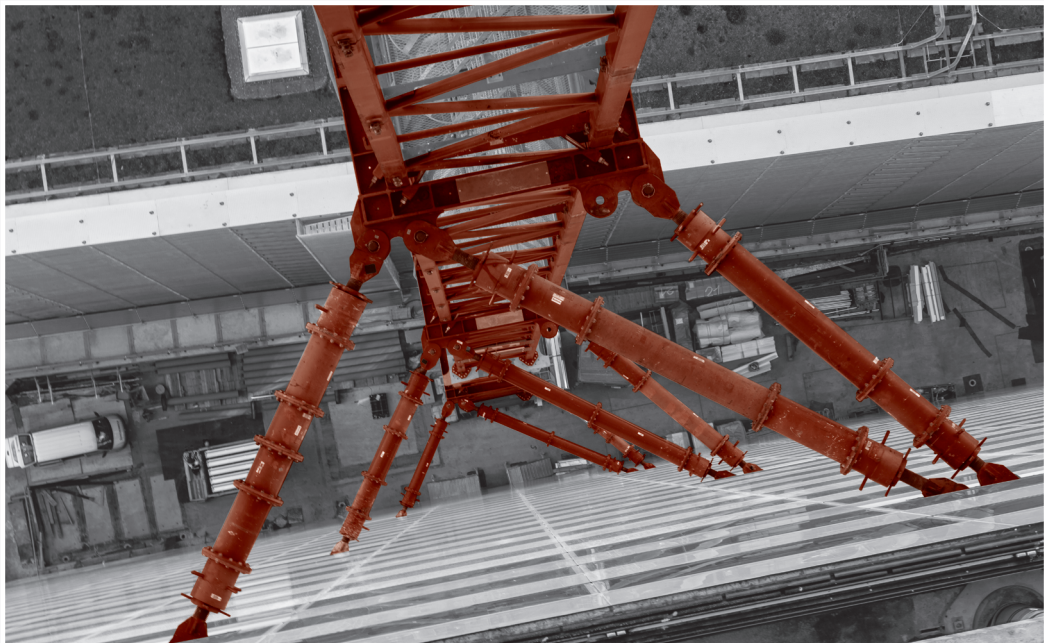

WOLFF System-Komponenten
System-components / Système de composants

WOLFF	Fundamentanker Foundation anchor / Ancres de fondation	218 - 223
WOLFF	Kreuzrahmen Crossframe / Croix de base	224 - 225
WOLFF	Fahrbare Kreuzrahmen Travelling crossframe / Croix de base roulante	226 - 227
WOLFF	Kreuzrahmenelemente & Unterwagen Crossframe elements & Undercarriage / Eléments croix de base & Chassis de translation	228 - 229
WOLFF	Cityportale Cityportals / Portiques city	230 - 231
WOLFF	Turmelemente Tower elements / Eléments de tour	233 - 241
WOLFF	Turmabspannung Tower tie / Ancrage horizontale	242
WOLFF	Aussenkletterwerke External climber / Mécanismes grim pant externe	243
WOLFF	Innenkletterwerke Internal climber / Mécanismes grim pant interne	244
WOLFF	Fundamentplatten Foundation plates / Plaques de fondation	246 - 247

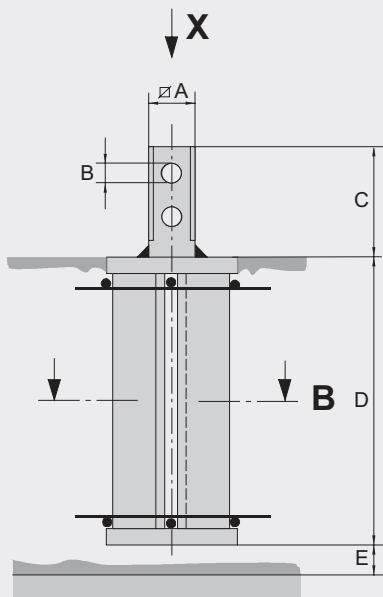

Ansicht „X“ / view / vue

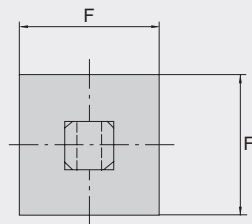

Schnitt A - B / section / section

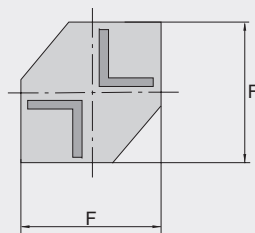

Fundamentanker Typ Foundation anchor type Ancre de fondation type	Zapfen(mm) Stud Cheville	Maße (mm) / Measure / Masse						Verwendbare Turmelemente Suitable tower elements Élément de tour propres	Gewicht pro Stück (kg) Weight per item Poids par pièce
		A	B	C	D	E	F		
B.4 - 93	93	93	50	330	1000	100	240	TFS 12 / TFS 15 / TFS 20	87
C - 120	120	120	60	360	1000	100	290	UV 15 / UV 20 / KSH 15 / KSH 20 M	124
D - 140	140	140	70	390	1000	100	370	TV 20 / TV 23 / TV 25	251
F - 156	156	156	70	395	1000	100	450	UV 25	360
FS - 156	156	156	75	395	1000	100	450	UV 25 S / KSH 20 SH	360

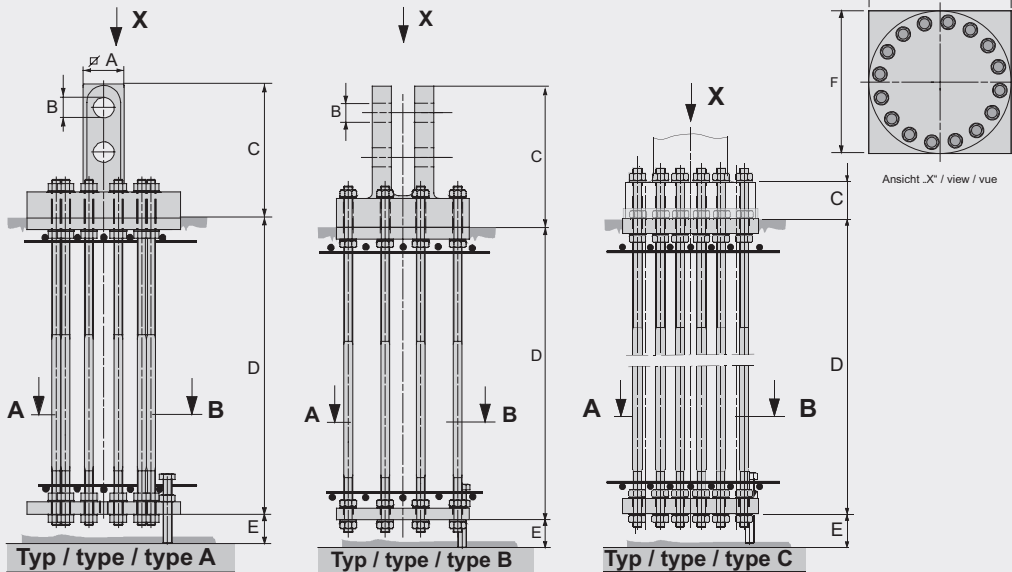

Fundamentanker Typ Foundation anchor type Ancre de fondation type	Typ type type	Zapfen(mm) Stud Cheville	Maße (mm) / Measure / Masse						Verwendbare Turmelemente Suitable tower elements Élément de tour propres	Gewicht pro Stück (kg) Weight per item Poids par pièce
			A	B	C	D	E	F		
FUA 93	A	93	93	50	355	1000	100	300	TFS 12 / TFS 15 / TFS 20	137
FUA 120	A	120	120	60	390	1000	100	400	UV 15 / UV 20 / KSH 15 / KSH 20 M	257
FUA 140	A	140	140	70	452	1000	100	400	TV 20 / TV 23 / TV 25	337
FUA 156	A	156	156	70	462	1000	100	500	UV 25	485
FUA 156 S	A	156	156	75	462	1000	100	500	UV 25 S / KSH 20 SH	485
FUA 160	B	160	160	60	487	1500	100	500	HT 23 / HTA 23	564
FUA UV 29	B	-	200	65	477	990	100	450	UV 29	452
FUA 210	B	210	210	70	537	1500	100	550	BT 23 / KSH 23 / TV 29	705
FUA BT 29	C	-	-	-	160	1500	100	450	BT 29	327

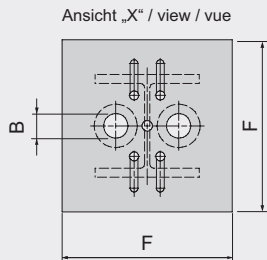
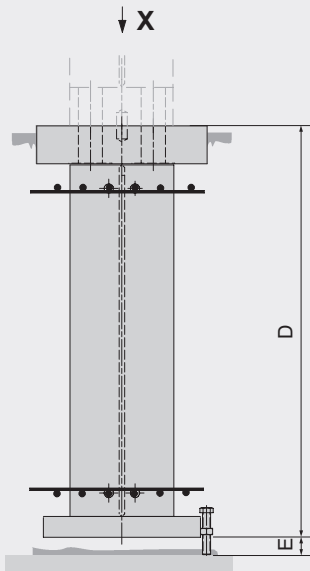

Fundamentanker Typ Foundation anchor type Ancre de fondation type	Zapfen(mm) Stud Cheville	Maße (mm) / Measure / Masse						Verwendbare Turmelemente Suitable tower elements Élément de tour propres	Gewicht pro Stück (kg) Weight per item Poids par pièce
		A	B	C	D	E	F		
G - 1500	-	-	93	-	1570	100	650	TV 33.4, TV 33.4 L, TV 33-5, TV 33-10	1060
G - 2000	-	-	93	-	2040	100	650	TV 33.4, TV 33.4 L, TV 33-5, TV 33-10	1165

WOLFF Kreuzrahmen / Crossframe / Croix de base

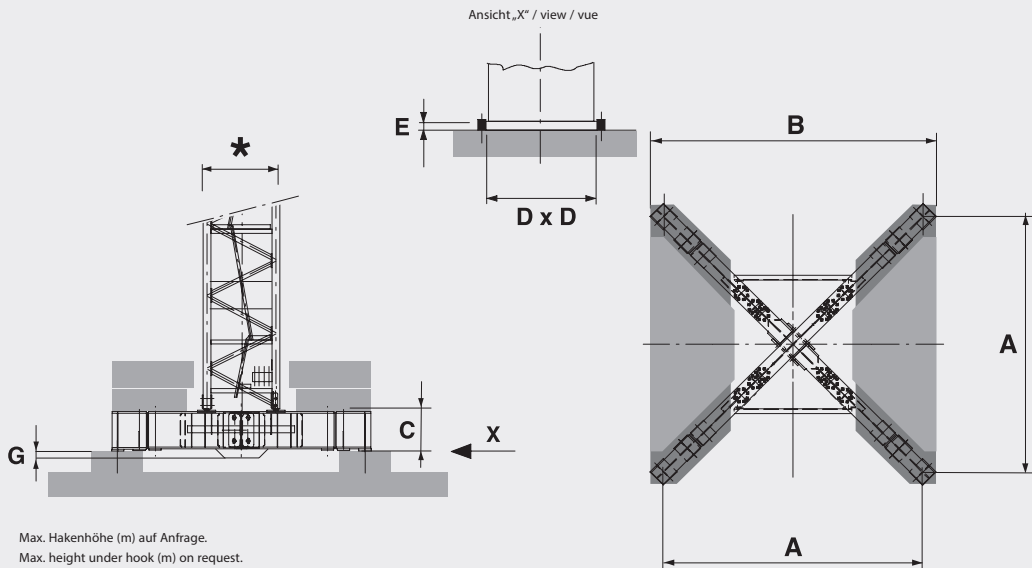

Kreuzrahmen Typ Crossframe type Croix de base type	Maße / Measure / Masse						* Turmanschluss Tower connection L'adaptateur de tour
	(m)				(mm)		
	A	B	C	D	E	G	
KR 6 - 40	4,0	4,5	0,7	0,32 x 0,32	20,0	0	TFS 12, TFS 15, UV 15
KRV 7 - 32	3,2	3,8	0,8	0,32 x 0,32	20,0	0	TFS 12, TSL 15, TFS 15, UV 15
KRV 7 - 32 / 46	4,6	5,1	0,9	0,32 x 0,32	20,0	0	TFS 12, TSL 15, TFS 15, UV 15, TFS 20, UV 20
KR 10 - 46	4,6	5,1	1,2	0,40 x 0,40	20,0	100	UV 20, TV 20
KR 10 - 46 / 60	6,0	6,5	1,2	0,45 x 0,40	50,0	100	UV 20, TV 20
KRV 10 - 60	6,0	6,7	1,2	0,55 x 0,45	30,0	300	UV 20 / TV 20 / TV 23 / TV 25
KR 12 - 60	6,0	6,8	1,4	0,55 x 0,55	20,0	600	UV 20 / TV 20, TV 23 / HT 23, TV 25 / UV 25
KR 12 - 60 / 80	8,0	8,8	1,4	0,55 x 0,55	20,0	600	UV 20 / TV 20, TV 23 / HT 23, TV 25 / UV 25
KR 16 - 80	8,0	8,8	1,8	0,55 x 0,55	40,0	430	HT 23, TV 25 / UV 25, TV 29, BT 29
KR 16 - 80 / 100	10,0	10,8	1,8	0,55 x 0,55	40,0	430	HT 23, TV 25 / UV 25, TV 29, BT 29

WOLFF Fahrbare Kreuzrahmen / Travelling crossframe / Croix de base roulante

Bild / figure / image 1



Bild / figure / image 2



Bild / figure / image 3

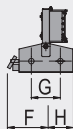

Fahrbarer Kreuzrahmen Travelling crossframe Croix de base roulante	Bild Figure Image	Maße (m) / Measure / Masse									Laufgrad (mm) Wheel Roue translation	Spurweite (m) Gauge Avec un écartement des rails	* Turmelemente Tower elements Éléments de tour	Fahrwerksdetails Chassis specifications Châssis spécifications
		A	B	C	D	E	F	G	H	I				
KRVF 7-32/46	1	4,60	5,99	1,50	0,21	0,52	0,72	0,54	0,58	-	Ø 400	4,60 x 4,60	TFS 12 TTSL / TFS 15 UV 15	Fw 401-KL-E; 2 x 5,5 kW; 25 m/min; S 49
KRF 10-46/60	1	6,00	7,85	2,00	0,23	0,52	1,02	0,90	0,84	-	Ø 630	6,00 x 6,00	UV 20 / TV 20	Fw 631-KL-E; 4 x 5,5 kW; 30 m/min; S 64
KRF4 12-60/80	2	8,00	11,03	2,50	0,21	0,52	0,72	0,54	0,58	1,60	Ø 400	8,00 x 8,00	UV 20 / TV 20 TV 23 / HT 23 TV 25 / UV 25	Fw 401-KL-E; 4 x 5,5 kW; 25 m/min; S 49
KRF6 12-60/80	3	8,00	12,13	2,90	0,23	0,52	1,02	0,90	0,84	2,10	Ø 630	8,00 x 8,00	UV 20 / TV 20 TV 23 / HT 23 TV 25 / UV 25	Fw 631-KL-E; 6 x 5,5 kW; 30 m/min; S 64
KRF 16-80/100	3	10,00	13,95	3,30	0,26	0,52	1,02	0,90	0,84	2,10	Ø 630	10,00 x 10,00	HT 23 TV 25 / UV 25 TV 29 / BT 29	Fw 631-KL-E; 8 x 5,5 kW; 30 m/min; S 64

S = Schienentyp / rail size / rail

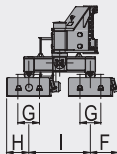
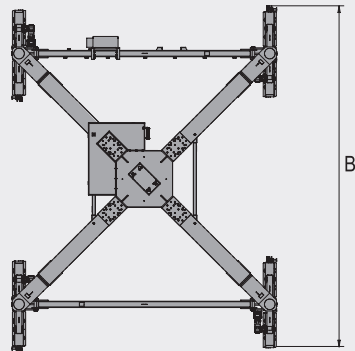
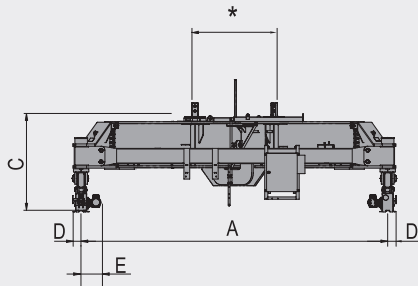
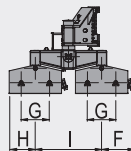
WOLFF Kreuzrahmenelement / Crossframe element / Élément croix de base

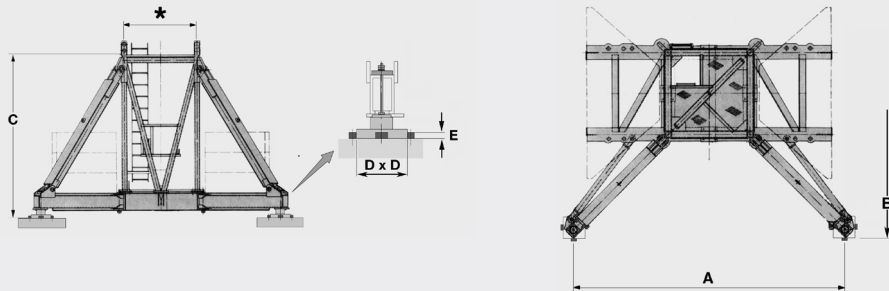

WOLFF Unterwagen / Undercarriage / Chassis de translation

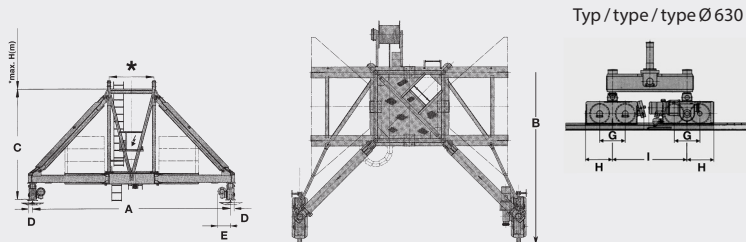

Max. Hakenhöhe (m) auf Anfrage. Max. height under hook (m) on request. Max. hauteur sous crochet (m) nous consulter.

Kreuzrahmenelement Typ Crossframe element type Élément croix de base type	Maße / Measure / Masse					Mögliche Eckabstände Possible corner distances Distance des appuis possibles	* Verwendbare Turmelemente Suitable tower elements Éléments de tour propres
	(m)				(mm)		
	A	B	C	D	E		
KRE 4120	12,0	12,7	8,7	0,70 x 0,70	60	12,0 x 12,0	TV 33-5, TV 33-10

Unterwagen Undercarriage Chassis de translation	Maße / Measure / Masse									Laufрад Wheel Roue translation (mm)	Eckabstände Corner distances Distance des appuis (mm)	* Turmelemente Tower elements Éléments de tour	Fahrwerkdetails Chassis specifications Châssis spécifications
	(m)												
	A	B	C	D	E	F	G	H	I				
UW 4120	12,0	16,2	10,0	0,54	0,23	0,00	0,90	0,84	2,10	Ø 630	12,0 x 12,0	TV 33-5 TV 33-10	Fw 631-KL-E; 8x5,5 kW; 30 m/min; R = 75 m; S 64

WOLFF Cityportal / Cityportal / Portique "City"

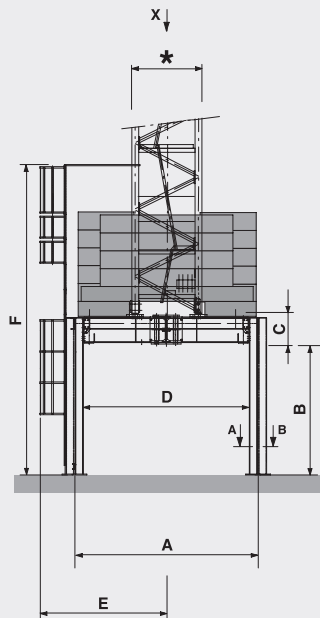

Ansicht „X“ / view / vue

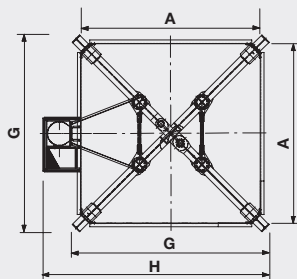

Cityportal Typ Cityportal type Portique „City“ type	Maße (m) / Measure / Masse								* Verwendbare Turmelemente Suitable tower elements Éléments de tour propres
	A	B	C	D	E	F	G	H	
CP 380	3,80	4,50	0,80	3,27	2,61	10,26	4,42	4,82	TFS 12, TSL 15, TFS 15, UV 15
CP 520	5,24	4,50	1,20	4,74	3,74	11,12	5,95	6,71	UV 20, TV 20
CP 690	6,92	4,50	1,67	6,20	4,30	8,58	7,74	8,18	UV 20 / TV 20 / TV 23 / HT 23 UV 25 / TV 25

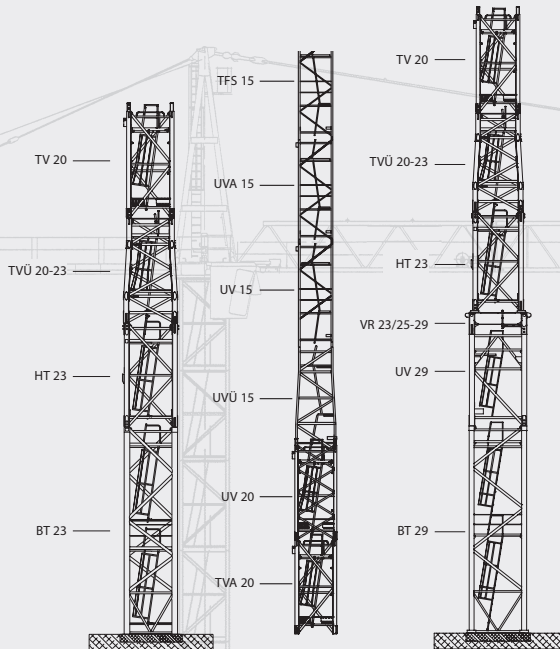

WOLFF Turmelemente Tower elements Éléments de tour

Beispiel einer Turmkombination mit System-Turmelementen
Example of a tower configuration with system tower elements
Exemple d'une combinaison d'éléments de tour

WOLFF Turmelemente und Übergang / Tower elements and adapter / Éléments de tour et transition

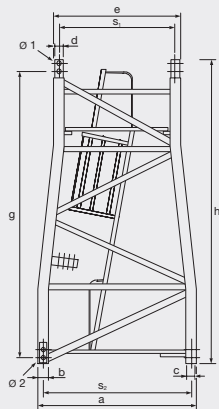
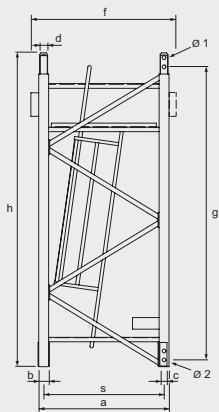

Typ / type / type Ü

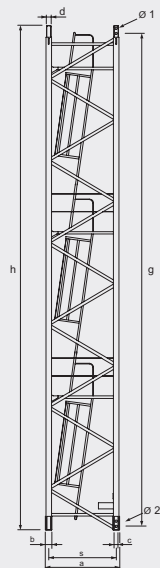

Typ / type / type L(C)

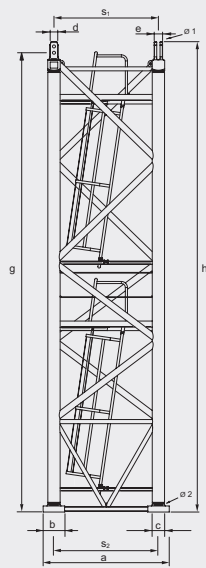

Typ / type / type BT

Turmelemente Typ (m) Tower elements type (m) Éléments de tour type (m)	12			15		
	□ 1,2 x 5,75 m	lang long long □ 1,2 x 11,5 m	Übergang Adapter Transition □ 1,2 x 4,5 m	□ 1,5 x 4,5 m	lang long long □ 1,5 x 13,5 m	□ 1,5 x 4,5 m
	TFS 12	TFS 12 LC	TFSÜ 12	TFS 15.6	TFS 15.6 L	UVA 15.6
kg	1994	2908	1654	1475	3625	1755
a (mm)	1200	1200	1500	1500	1500	1500
b (mm)	120	120	120	121	121	151
c (mm)	98	98	98	98	98	126
d (mm)	93	93	93	93	93	93
e (mm)	-	-	-	-	-	-
f (mm)	-	-	-	1630	-	1630
g (mm)	5750	11500	4500	4500	13500	4500
h (mm)	5893	11785	4785	4785	13785	4785
s ₁ (mm)	-	-	1080	-	-	1379
s / s ₂ (mm)	1080	1080	1379	1379	1379	1349
Ø 1 (mm)	50	50	50	50	50	50
Ø 2 (mm)	50	50	50	50	50	60

Turmelemente Typ (m) Tower elements type (m) Éléments de tour type (m)	15					
		lang long long		kurz short courte		lang long long
	□ 1,5 x 4,5 m	□ 1,5 x 13,5 m	□ 1,5 x 4,5 m	□ 1,5 x 2,25 m	□ 1,5 x 4,5 m	□ 1,5 x 11,25 m
	UV 15.6	UV 15.6 L	TVA 15.6	TV 15.6 K	TV 15.6	TV 15.6 LC
kg	1820	4645	2905	1770	2930	6475
a (mm)	1500	1500	1500	1500	1500	1500
b (mm)	151	155	182	182	182	182
c (mm)	126	129	147	147	147	147
d (mm)	120	120	118	140	140	140
e (mm)	-	-	-	-	-	-
f (mm)	1630	-	1635	-	1635	-
g (mm)	4500	13500	4500	2250	4500	11240
h (mm)	4815	13815	4815	2590	4840	11590
s ₁ (mm)	-	-	1346	-	-	-
s / s ₂ (mm)	1349	1349	1318	1318	1318	1318
Ø 1 (mm)	60	60	60	70	70	70
Ø 2 (mm)	60	60	70	70	70	70

Turmelemente Typ (m) Tower elements type (m) Éléments de tour type (m)	15		20				
	lang long long	Übergang Adapter Transition	□ 2,0 x 4,5 m	kurz short courte	□ 2,0 x 4,5 m	□ 2,0 x 11,25 m	lang long long
	□ 1,5 x 13,5 m	□ 1,5 x 4,5 m		□ 2,0 x 2,25 m			□ 2,0 x 13,5 m
	TV 15.6 L	TVÜ 15.6	UVA 20.6	UV 20.6 K	UV 20.6	UV 20.6 LC	UV 20.6 L
kg	7580	4150	2075	in Vorbereitung / in preparation / en préparation	2130	in Vorbereitung / in preparation / en préparation	5790
a (mm)	1500	2064	2000		2000		2004
b (mm)	182	216	151		151		155
c (mm)	147	176	126		126		129
d (mm)	140	140	93		120		120
e (mm)	-	1564	-		-		-
f (mm)	-	-	2130		2130		-
g (mm)	13500	4500	4500		4500		13500
h (mm)	13840	4850	4785		4815		13815
s ₁ (mm)	-	1318	1879		-		-
s / s ₂ (mm)	1318	1818	1849	1849	1849		
Ø 1 (mm)	70	70	50	60	60		
Ø 2 (mm)	70	70	60	60	60		

Turmelemente Typ (m) Tower elements type (m) Éléments de tour type (m)	20					
	□ 2,0 x 4,5 m TVA 20.6	kurz short courte □ 2,0 x 2,25 m TV 20.6 K	□ 2,0 x 4,5 m TV 20.6	lang long long □ 2,0 x 11,25 m TV 20.6 LC	□ 2,0 x 13,5 m TV 20.6 L	Übergang Adapter Transition □ 2,3 x 4,5 m TVÜ 20-23
kg	3180	in Vorbereitung / en préparation	3040	in Vorbereitung / en préparation	7995	4300
a (mm)	2000		2000		2030	2320
b (mm)	182		182		182	216
c (mm)	147		147		147	176
d (mm)	118		140		140	140
e (mm)	-		-		-	2034
f (mm)	2120		2135		-	-
g (mm)	4500		4500		13500	4500
h (mm)	4815		4840		13840	4860
s ₁ (mm)	1846		-		-	1818
s / s ₂ (mm)	1818	1818	1818	2074		
Ø 1 (mm)	60	70	70	70		
Ø 2 (mm)	70	70	70	60		

Turmelemente Typ (m) Tower elements type (m) Éléments de tour type (m)	23			29			
	□ 2,3 x 4,5 m	□ 2,3 x 11,25 m		□ 2,9 x 4,5 m			□ 2,9 x 10,0 m
	HT 23	BT 23	BT 23 S	UV 29	TVA 29	TV 29	BT 29
kg	3925	11390	11230	4630	6150	5660	9175
a (mm)	2305	2320	2320	2830	2845	2845	3010
b (mm)	246	266	266	250	265	265	430
c (mm)	216	226	226	218	225	225	360
d (mm)	166	160	213	208	208	210	208
e (mm)	-	166	213	200	200	-	200
f (mm)	-	-	2404	-	-	-	-
g (mm)	4500	11250	11250	4500	4500	4500	10000
h (mm)	4840	11590	11630	4850	4850	4865	10350
s ₁ (mm)	-	2074	2024	-	2580	-	-
s / s ₂ (mm)	2074	2024	2024	2580	2565	2565	2580
Ø 1 (mm)	60	60	70	65	65	70	65
Ø 2 (mm)	60	70	70	65	70	70	16 x 33

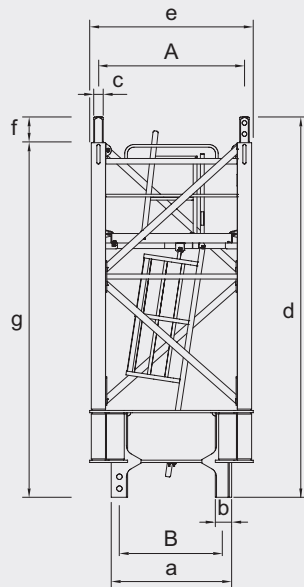
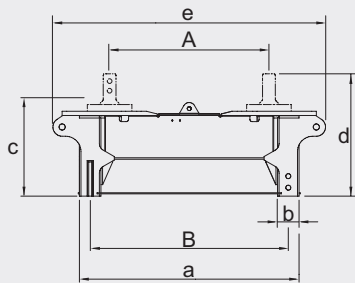

Verbindungsrahmen Typ Connection frames type Cadre de réduction type	kg	Maße (mm) / Measure / Masse							Verwendbare Turmelemente / Suitable tower elements / Éléments de tour propres	
		a	b	c	d	e	f	g	A	B
VR 2015.1	4420	1525	207	120	4815	2071	325	4500	UV 20	TV 15
VR 2023	2456	2324	219	1010	1350	2780	-	-	TV 20	TV 23
VR 23/25-29	4275*	2860	280	1267 1217	1687	3550	-	-	HTA 23 / HT 23 TV 23 / TV 25 / UVA 25 / UV 25	BT 29 / UV 29
VR 23/25-29.1	6350*	2830	265	1267 1217	1597	3550	-	-	HTA 23 / HT 23 TV 23 / TV 25 / UVA 25 / UV 25	TV 29
VR 2523	3180	2324	250	1132	1472	2780	-	-	TV 25	HT 23
VR 2933	8140	3370	-	2037	2297	3370	-	-	TV 29	TV 33-5

*ohneAufschraubzapfen/withoutspigots/sansTenons

WOLFF Turmabspannung / Tower ties / Ancrages horizontales

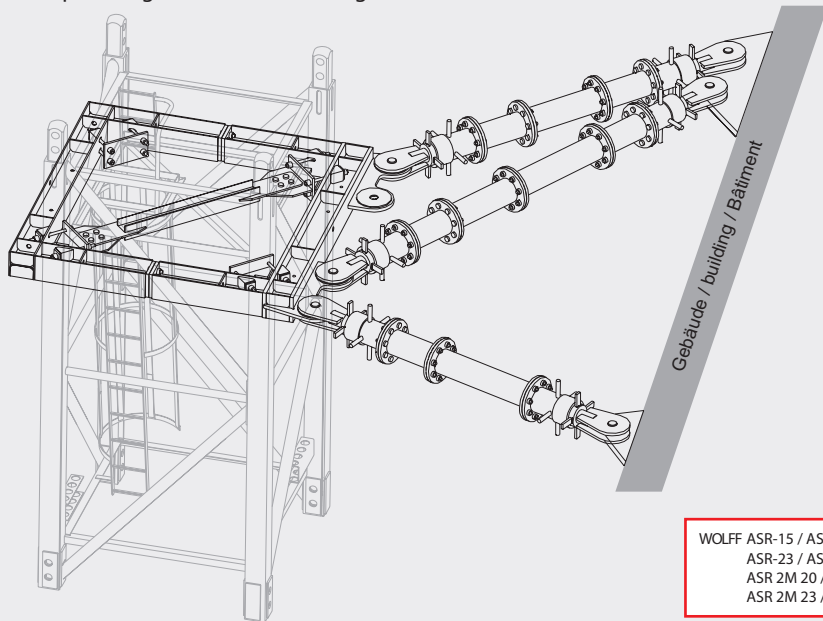

WOLFF ASR-15 / ASR-20 / ASRV-20
ASR-23 / ASR-29 / ASR-33
ASR 2M 20 / ASR 3M 20
ASR 2M 23 / ASR 3M 23

WOLFF Aussenkletterwerke / External climber / Mécanisme grim pant externe

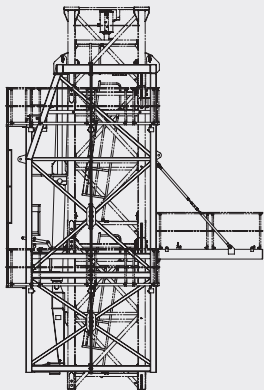

Aussenkletterwerkere Typ External climber type Mécanismegrim pantexternetype	KWH 15.2	KWH 20.3.1	KWH 20.6.1	KWH 23	KWH 29	KWH 33
Kletterbare Turmelemente Climbable tower elements Sections de fûts pour grimper	TFS 15 TFSA 15 UV 15	TFS 20 TFSA 20 UV 20 TV 20 TVA 20	UV 20 TV 20 TVA 20	TV 23 HT 23	TV 29 UV 29	TV 33-5

WOLFF Innenkletterwerke / Internal climber / Mécanisme grim pant interne

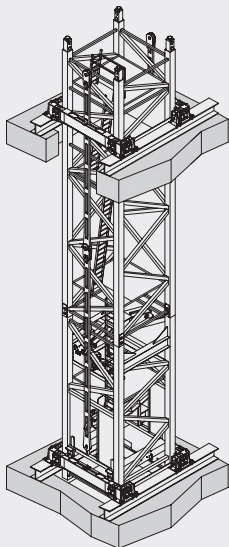

Innenkletterwerke Typ Internal climber type Mécanisme grim pant interne type	KSH 15	KSH 20 M	KSH 20 SH	KSH (E) 23	KSH (E) 23 - BT 23
Turmanschluss Tower connection Raccord de fût	UV 15 UVA 15	UV 20.4 LC	TV 20 TVA 20	HT 23	BT 23
Deckenöffnung Slab / floor opening Overture de toit	□ 1,8 m	□ 2,5 m	□ 2,5 m	(□ 2,7 m) □ 3,54 m x 3,19 m	(□ 2,7 m) □ 3,54 m x 3,19 m

Typ A / Type A / Type A

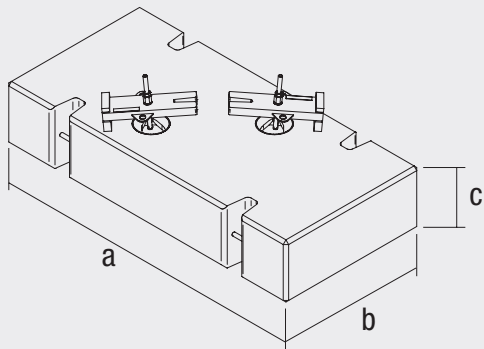

Typ B / Type B / Type B

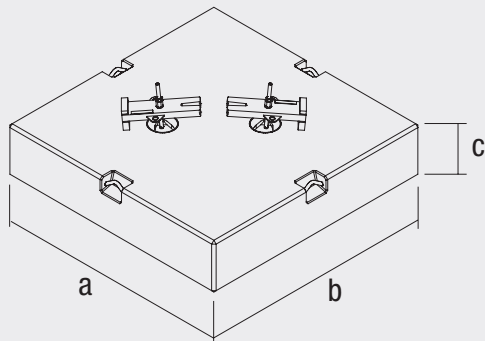

Fundamentplatten Foundation plates Plaques de fondation	Typ Type Type	Maße / Measure / Masse (m)			Gewicht Weight Poids (kg)	max. Ecklast max. corner load Charge d'angle max. (kN)
		a	b	c		
FP 15/15	B	1,5	1,5	0,48	2500	700
FP 12/26	A	2,6	1,24	0,5	3750	1100
FP 23/23	B	2,3	2,3	0,8	6250	1800





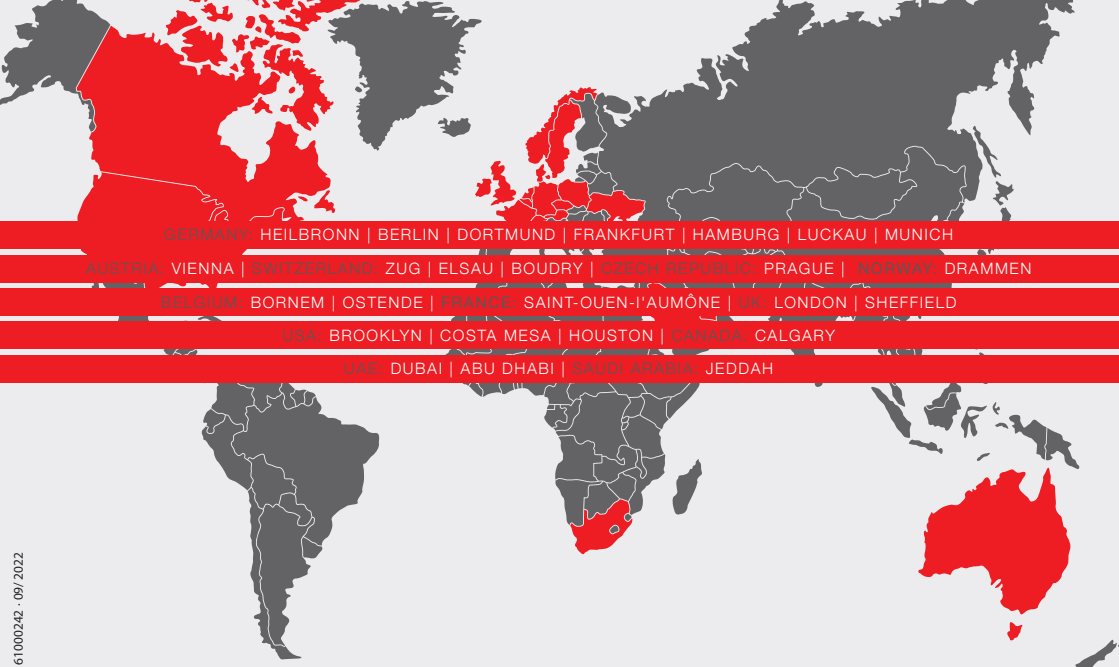

GERMANY: HEILBRONN | BERLIN | DORTMUND | FRANKFURT | HAMBURG | LUCKAU | MUNICH

AUSTRIA: VIENNA | SWITZERLAND: ZUG | ELSAU | BOUDRY | CZECH REPUBLIC: PRAGUE | NORWAY: DRAMMEN

BELGIUM: BORNEM | OSTENDE | FRANCE: SAINT-OUEN-L'AUMÔNE | UK: LONDON | SHEFFIELD

USA: BROOKLYN | COSTA MESA | HOUSTON | CANADA: CALGARY

UAE: DUBAI | ABU DHABI | SAUDI ARABIA: JEDDAH

WOLFFKRAN Werk Brandenburg GmbH
Frederik-Ipsen-Straße 5
D-15926 Luckau
Tel. +49 35456 674-0
Fax +49 35456 674-200
info@wolffkran.de
www.wolffkran.de

WOLFFKRAN GmbH
Austraße 72
D-74076 Heilbronn
Tel. +49 7131 9815-0
Fax +49 7131 9815-355
info@wolffkran.de
www.wolffkran.de

WOLFFKRAN International AG
Baarermattstrasse 6
CH-6430
Tel. +41 41 766 85 00
Fax +41 41 766 85 99
info@wolffkran.com
www.wolffkran.com

www.wolffkran.com